



Section 20

ISS Design Analysis Cycle & Environment Predictions

**Microgravity Environment Interpretation Tutorial
NASA Glenn Research Center
March 2-4, 2004**

Brad Humphreys

Microgravity Control Team

ZIN Technologies

3000 Aerospace Parkway

Brook Park, OH 44142

216-977-0360

Presentation Overview

- **Design Analysis Cycle, DAC**
 - **Quasi-Steady Environment**
 - Methods & Tools
 - Results
 - **Vibratory Environment**
 - Methods & Tools
 - Results
- **Verification Analysis Cycle**
- **Non-Isolated Rack Assessment, NIRA**
- **Microgravity Analysis Cycle (MAC)**

Acknowledgements

- **DAC/VAC – Design Analysis Cycle, Verification Analysis Cycle**
 - **JSC Microgravity Team – MIPT (Microgravity Integrated Performance Team)**
 - James Smith, james.p.smith1@jsc.nasa.gov

- **NIRA – Non Isolated Rack Assessment**
 - **NASA GRC, NIRA Team**
 - Bill Hughes, william.o.hughes@nasa.gov

- **MAC – Microgravity Analysis Cycle Tool**
 - **NASA GRC, PIMS**
 - Brad Humphreys, bradley.t.humphreys@grc.nasa.gov

Acronyms

AC	: Assembly Complete	NASTRAN	: NASA Structural Analysis
APM	: Attached Payload Module	NASDA	: National Space Development Agency of Japan
ARIS	: Active Rack Isolation System	NIRA	: Non Isolated Rack Assessment
CAM	: Centrifuge Accommodations Module	PaRIS	: Passive Rack Isolation System
CBM	: Common Berthing Mechanism	PDR	: Preliminary Design Review
CDR	: Critical Design Review	PIDS	: Prime Item Development Specification
CEVIS	: Cycle Ergometer with Vibration Isolation System	PIMS	: Principal Investigator Microgravity Services
CMG	: Control Moment Gyro	PM	: Pressurized Module
COF	: Columbus Orbital Facility	PMA	: Pressurized Mating Adapter
DAC	: Design Analysis Cycle	RMS	: Root Mean Square
EF	: Exposed Facility	RS	: Russian Segment
ELM	: Experiment Logistics Module	SEA	: Statistical Energy Analysis
ESA	: European Space Agency	SM	: Service Module
FEA	: Finite Element Analysis	SARJ	: Solar Array Rotary Joints
GN&C	: Guidance, Navigation, and Control	SPP	: Science Power Platform
GRC	: Glenn Research Center	SSMRBS	: Space Station Multi Rigid Body Simulation
ISPR	: International Standard Payload Rack	TRRJ	: Thermal Radiator Rotary Joints
I/F	: Interface	TVIS	: Treadmill Vibration Isolation System
JAXA	: Japanese Exploration Agency	USOS	: United States On-orbit Segment
JEM	: Japanese Experiment Module	UF	: Utilization Flight
JSC	: Johnson Space Center	VAC	: Verification Analysis Cycle
MAC	: Microgravity Analysis Cycle		

Design Analysis Cycles

Design Analysis Cycles (DACs) may be viewed as PDR/CDR level analyses or “special” case studies.

- DAC-9 was completed in March 2002.
- DACs capture updated models & disturbance forcing functions.
- System model (several analytical models) developed for Assembly-Complete (AC) configuration when micro-g requirements become applicable.
- System model development is an evolutionary process through Design Analysis Cycles (DAC). Current cycle is DAC-9.
- Each cycle reflects the current assembly sequence and the updated component models. Test-verified (VAC quality) models are available for components that have already flown.

Quasi-steady Analysis Methods & Tools

- **Perform integrated analysis to ensure that the microgravity quasi-steady disturbances will not exceed the quasi-steady acceleration limits for the International Space Station at Assembly Complete using the μg control plan inputs.**
- **System Level**
 - **Frequencies $< .01$ Hz, $1.0 \mu\text{g}$ Peak and $.2 \mu\text{g}$ perpendicular component**
- **Element level**
 - **Quasi-steady microgravity requirements flow down to the PIDS as an allocation of $.02 \mu\text{g}$ on individual disturbances, excluding the effect of drag and gravity gradient. US LAB and HAB are allocated $0.04 \mu\text{g}$ each for all combined quasi-steady disturbances**
- **Quasi-steady Individual Disturbance defined as:**
 - **Quasi-steady disturbance is defined as having 95% of its power below 0.01 Hz in any 5400 second period**
 - Any step function greater than 200 seconds
 - Any exponential decay with a time constant greater than 200 seconds
 - Other disturbances analyzed for percentage content below 0.01 Hz
- **Perform studies to compare Orbiter attached, Core complete mass properties, maximum and no aerodynamics runs**

Quasi-steady Analysis Methods & Tools

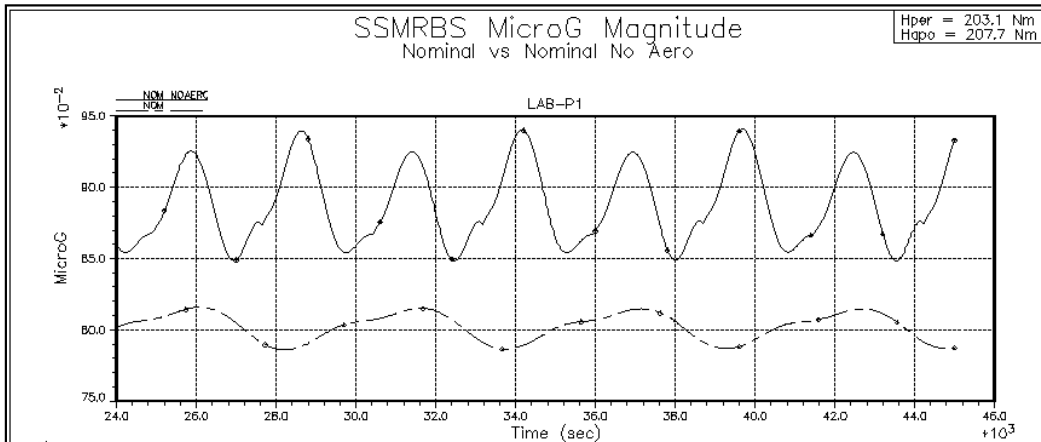

- Below 0.01 Hz**
- **Orbital Mechanic Multi-Rigid Body Closed Loop Attitude Control Analysis**
 - **Space Station Multi Rigid Body Simulation**
 - **SSMRBS used for GN&C Software Verification**

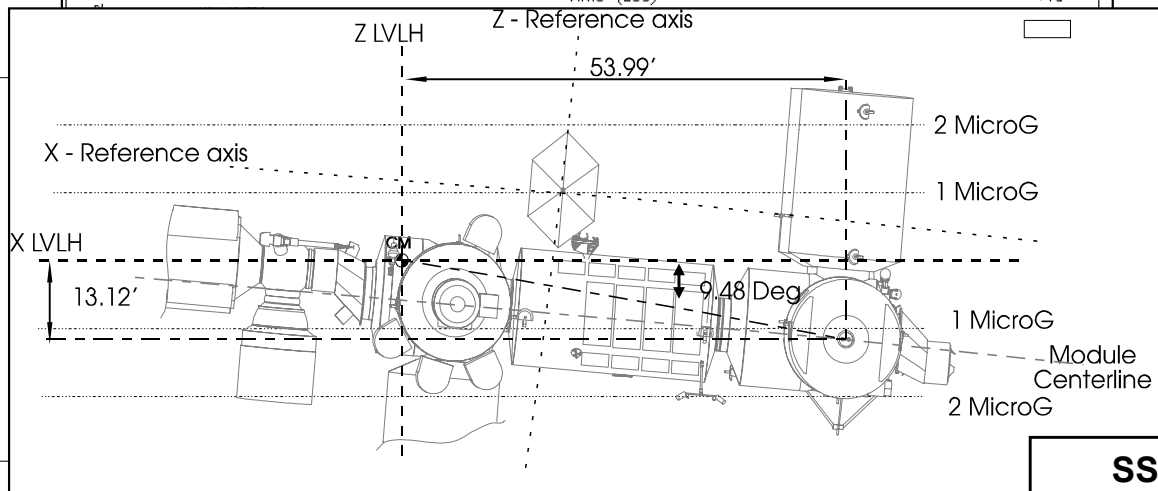

$$\vec{a} = -\mu \left(\frac{\vec{r}_p}{r_p^3} - \frac{\vec{r}_g}{r_g^3} \right) - \vec{\omega} \times \left(\vec{\omega} \times \vec{r}_{p/g} \right) - \dot{\vec{\omega}} \times \vec{r}_{p/g} + \vec{a}_D$$

Gravity Gradient
Centripetal
Tangential
Aero-Dynamic Drag

SSMRBS Environment Data Validation

**verify_gfield
(gravity)**

ADA Advanced Simulation Development System (ASDS)
Gravitational Potential (GOTPOT) model

**verify_bfield
(magnetic)**

Goddard Space Flight Center International Geophysical Reference Field (IGRF) Earth Magnetic model

**verify_atm_density
(density)**

Marshall Engineering Thermosphere (MET) Earth Atmospheric Density model

Quasi-steady Analysis Disturbance Inputs

- **Centrifuge startup and shut down**
 - Spin-up for 120 sec to 236 deg/s, spin for 6.4 hours, spin-down for 120 sec.
 - Starts at 17000 sec
- **TRRJ slew at low betas**
 - TRRJ 0 beta slew rates - TRRJ Torque Power Spectral Density has 87.7% of its power below 0.01 Hz.
 - Not Applicable
- **Solar Thermal base loads**
 - Exponential decay for 210 seconds every 2160 seconds (night), 3360 (day), forces combined for eight arrays
 - Lighting dependent , continuous
- **LAB4 Vent**
 - Force profile, duration of 8700 seconds
 - Starts at 6000 seconds
- **RSA6 Vent**
 - Exponential decay of 600 seconds every 9000 seconds
 - Starts at 10000 seconds
- **Treadmill Gyro Start-up**
 - +0.23 ft-lbs. for 10 minutes, 0 ft-lbs. for 60 minutes, -0.23 ft-lbs. for 10 minutes, repeated every 30 minutes.
 - Starts at 6000 seconds

Quasi-steady Results DAC 9 – Assembly Complete

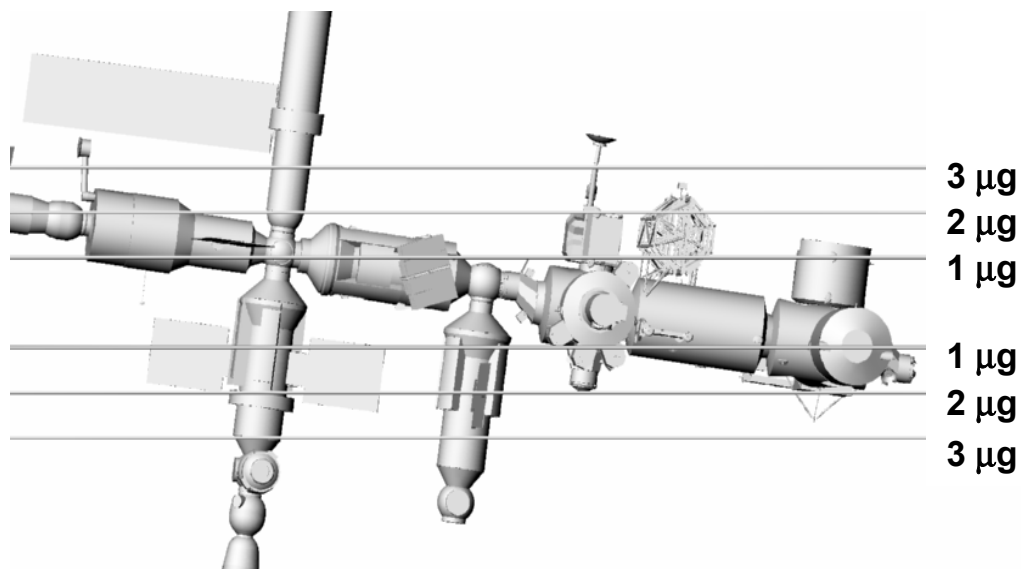

Some elements not shown

Quasi-steady Performance:

- 14 of 32 ISPRs < 1.0 μg
- All satisfy stability criteria

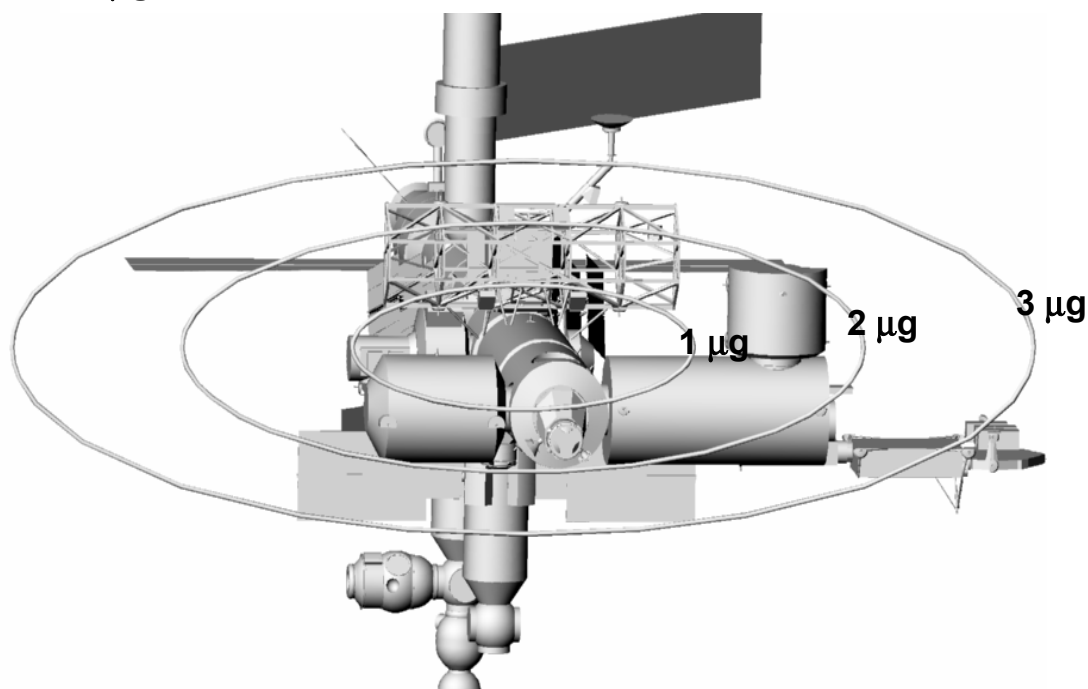

Quasi-steady Results DAC 9 – Assembly Complete

Location	μG Vector		Unit Vector			Cone Angle	Location	μG Vector		Unit Vector			Cone Angle
	Magnitude (μG)	⊥ Component (μG)	X	Y	Z	Max angle from unit vector (deg)		Magnitude (μG)	⊥ Component (μG)	X	Y	Z	Max angle from unit vector (deg)
CG	0.234	0.038	-0.995	-0.090	0.030	20.885	CAM-MID	1.518	0.111	0.068	-0.104	0.992	4.281
USL-C1	0.298	0.083	-0.630	-0.500	-0.594	18.659	CAM-TOP	2.306	0.111	0.093	-0.060	0.994	2.794
USL-C2	0.266	0.066	-0.751	-0.529	-0.395	22.312	APM-CLG3	0.875	0.116	-0.318	0.711	-0.627	7.587
USL-C3	0.244	0.045	-0.854	-0.518	-0.054	22.811	APM-CLG4	0.990	0.117	-0.296	0.773	-0.561	6.815
USL-C4	0.237	0.059	-0.830	-0.411	0.378	23.246	JEF1-F1	2.980	0.121	-0.057	-0.749	-0.660	2.388
USL-C5	0.245	0.085	-0.672	-0.249	0.698	24.359	JEF2-A1	2.682	0.115	-0.049	-0.795	-0.605	2.511
USL-S1	0.796	0.107	-0.315	0.096	-0.944	7.781	JEF3-F2	3.074	0.122	-0.049	-0.772	-0.633	2.336
USL-S2	0.743	0.105	-0.330	0.128	-0.935	8.237	JEF4-A2	2.800	0.116	-0.041	-0.814	-0.579	2.431
USL-S3	0.691	0.104	-0.348	0.165	-0.923	8.739	JEF5-F3	3.181	0.123	-0.042	-0.793	-0.608	2.286
USL-S4	0.642	0.102	-0.369	0.208	-0.906	9.291	JEF6-A3	2.914	0.117	-0.034	-0.833	-0.552	2.364
USL-P1	0.811	0.107	-0.247	-0.401	-0.882	7.632	JEF7-F4	3.299	0.125	-0.036	-0.809	-0.586	2.238
USL-P2	0.754	0.105	-0.259	-0.412	-0.874	8.124	JEF8-A4	3.022	0.119	-0.026	-0.850	-0.526	2.306
USL-P4	0.641	0.102	-0.288	-0.439	-0.851	9.320	JEF9-O1	3.412	0.127	-0.022	-0.849	-0.528	2.181
JPM1-A1	1.187	0.111	-0.159	-0.593	-0.789	5.480	JEF10-O2	3.321	0.124	-0.018	-0.862	-0.506	2.198
JPM2-F1	1.349	0.114	-0.154	-0.556	-0.817	4.959	JEF11-U1	2.599	0.123	0.005	-0.944	-0.330	2.766
JPM3-A2	1.266	0.111	-0.135	-0.669	-0.731	5.143	JEF12-U2	2.714	0.124	0.015	-0.957	-0.289	2.663
JPM4-F2	1.422	0.114	-0.134	-0.628	-0.766	4.705	S3LO	3.268	0.163	-0.125	0.982	0.141	2.877
JPM5-A3	1.355	0.111	-0.114	-0.730	-0.674	4.809	S3LI	2.931	0.155	-0.125	0.978	0.165	3.072
JPM6-F3	1.506	0.114	-0.115	-0.688	-0.716	4.449	S3UO	3.950	0.152	-0.042	0.830	0.556	2.272
JPM7-A4	1.453	0.111	-0.094	-0.779	-0.620	4.491	S3UI	3.683	0.145	-0.034	0.797	0.603	2.324
JPM8-A5	1.558	0.112	-0.077	-0.817	-0.571	4.197	P3LO	3.374	0.122	0.104	-0.958	0.269	2.078
JPM9-F5	1.696	0.114	-0.081	-0.779	-0.622	3.963	P3UO	4.202	0.113	0.142	-0.764	0.629	1.546
JPM10-F6	1.801	0.115	-0.067	-0.812	-0.579	3.745	FGB-CG	1.487	0.121	-0.028	0.851	0.525	4.741
APM-CLG1	0.668	0.112	-0.369	0.498	-0.785	9.613	SM-CG	1.651	0.106	0.030	0.265	0.964	3.990
APM-CLG2	0.759	0.113	-0.344	0.631	-0.695	8.593	USL-CG	0.664	0.103	-0.326	-0.138	-0.935	9.030
APM-FWD1	1.246	0.116	-0.263	0.227	-0.938	5.338	JEM-CG	1.560	0.113	-0.083	-0.795	-0.601	4.246
APM-FWD2	1.300	0.116	-0.265	0.330	-0.906	5.144	APM-CG	1.267	0.116	-0.272	0.410	-0.871	5.247
APM-FWD3	1.369	0.117	-0.265	0.422	-0.867	4.919							
APM-FWD4	1.449	0.118	-0.262	0.500	-0.826	4.693							
APM-AFT1	1.110	0.113	-0.281	0.299	-0.912	5.869							
APM-AFT2	1.174	0.114	-0.280	0.407	-0.869	5.595							
APM-AFT3	1.254	0.115	-0.276	0.501	-0.820	5.295							
APM-AFT4	1.342	0.117	-0.270	0.576	-0.772	5.005							

- Rack count 14 of 32 less than 1 μg
- Good stability, all 32 racks below 0.2 μg

Quasi-steady Results DAC 9 - Assembly Complete, Comparison

14 of 32 racks less than 1 μg magnitude

Configuration	CG			Principle Axis			Mass	Rack count under 1 μg
	X-ft	Y-ft	Z-ft	Y-deg	P-deg	R-deg	lb.	
7/15/94	-24.77	-0.7	13.55	-5.1	-3.31	0.12	836955	18
3/13/95 (DAC1)	-23.49	-2.26	12.67	-8.15	-4.13	-0.23	896110	16
DAC2	-23.41	-3.02	11.71	-6.17	-4.15	0.08	855301	14
DAC3	-23.07	-1.51	12.9	-1.24	-5.53	0.49	893181	11
DAC4	-21.23	-0.96	15.51	-3.34	-8.28	0.27	893045	14
DAC5	-22.08	-1.19	15.82	-4.05	-9.41	0.1	900412	10
DAC6	-19	-1.18	14.7	-3.26	-7.25	0.37	920170	14
DAC7	-16.21	-0.67	14.74	-5.87	-8.15	-0.16	994969	14
DAC8	-15.34	-1.28	14.87	-8.44	-6.13	0.12	1035473	15
DAC9	-17.66	-1.32	14.8	-6.36	-7.04	0.28	1005479	14
DAC9_CORE	-19.35	-0.59	14.93	-12.55	-10.53	-0.59	947788	10
DAC9_CORE_ADJ	-16.27	-0.63	13.76	-8.78	-9.93	0.14	902738	8
DAC9_ORB	-4.24	-1.09	22.03	8.97	9.49	-1.1	1222209	2
DAC9_CORE_ORB	-4.94	-0.49	22.5	15.4	5.96	-0.76	1164518	3
DAC9_CORE_ORB_ADJ	-1.88	-0.51	21.86	32.12	7.19	-3.68	1119471	4

Vibratory Analysis (Structural Dynamic) Methods & Tools

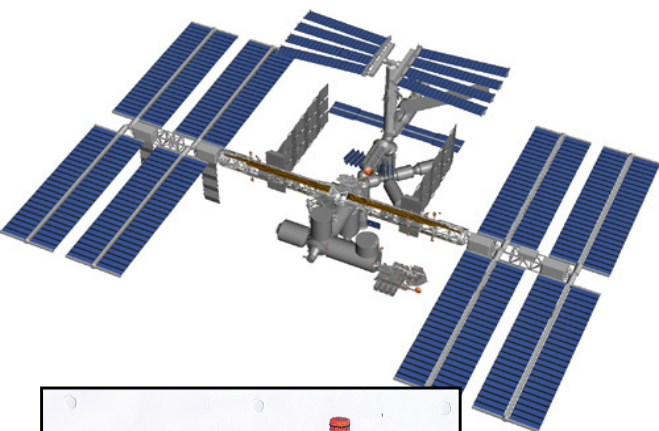

Enhanced COF Model

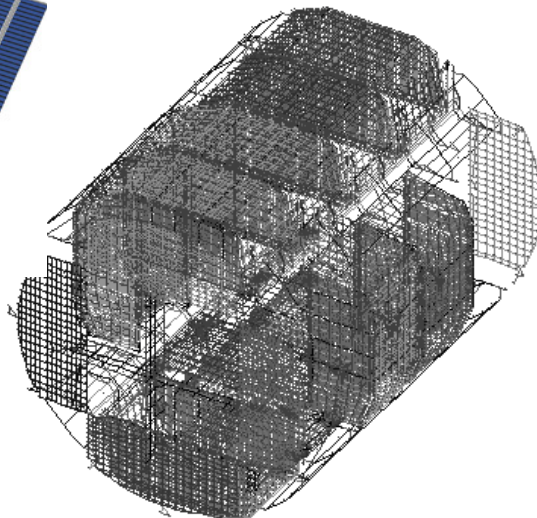

0.01 to 50 Hz
Structural Dynamic Finite Element Analysis
MSC/NASTRAN "Enhanced" Loads & Dynamics Models

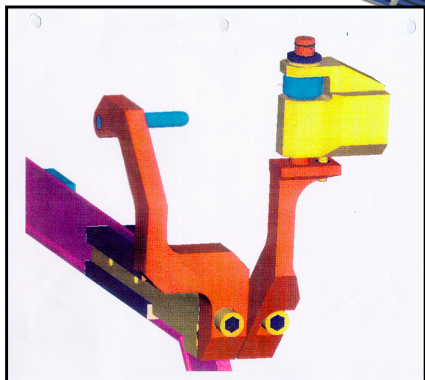

Lower Pivot



Non-isolated Rack I/F

Rack KBAR Attachment

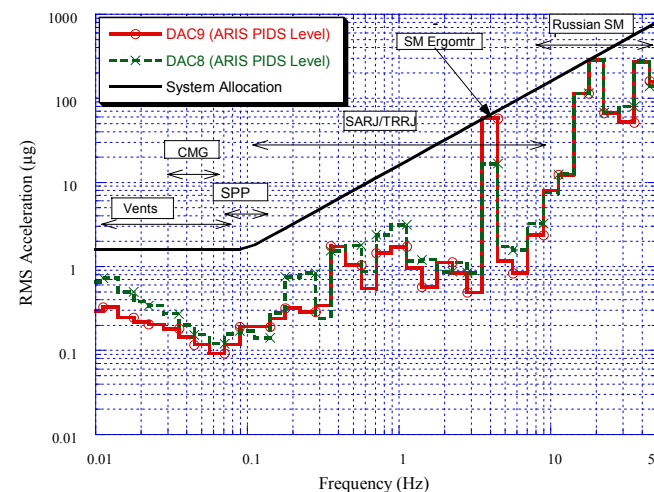
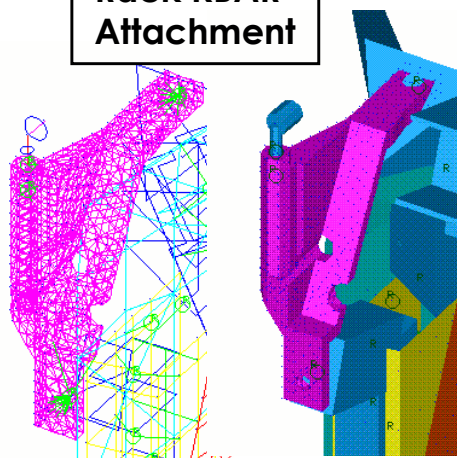

Vibratory Analysis Methods and Assumptions

- “Structural dynamic” micro-gravity assessments (0 to 50 Hz.)
- Frequency domain analysis for steady-state disturbances
 - Analysis frequency vector superposition of 2 frequency sets
 - **8457 system modes resonant frequencies**
 - **2000 supplemental frequencies at constant logarithmic spacing.**
- Time domain simulations for transient disturbances
 - Simulations performed with 0.01 second time step to have Nyquist frequency of 50 hz
 - Simulations performed for 100 seconds provide data down to lower frequency limit of 0.01 hz.
- 0.25% damping for all modes
- ARIS attenuation applied (PIDS level)

Vibratory Analysis Finite Element Models

- Component models obtained from various sources - element developers, international partners.
- Models usually obtained through Loads & Dynamics AIT
- Some models obtained directly from source
- Models come in various formats: simple stick-beam representations, detailed bulk data, reduced mass/stiffness matrices.
- **CONFIGURATION**
 - DAC-8 system model represented Rev.C configuration. This was updated to Rev. F configuration for DAC-9, major differences in Russian segment.
 - Node 4 / Propulsion module not included.
- **COMPONENT MODELS**

COMPONENT MODELS	SOURCE
• US Laboratory Module (US Lab)	Boeing Huntsville
• Japanese Experiment Module (JEM)	JAXA
• ESA Attached Pressurized Module (APM) aka COF	ESA
• Centrifuge Accommodation Module (CAM)	JAXA
• Node 2 and Node 3	Alenia
• Photovoltaic (PV) Arrays	Boeing CP

Vibratory Analysis Finite Element Model Example – US Lab US Lab Finite Element Model (Boeing)

- US Lab model comprised of 32 Superelements: Shell, Forward ESS, Aft ESS, 4 Standoffs, 12 Racks, 12 Isolation Plates
- Includes detailed rack models and attachments - pivot pins, K-bars, knee braces, bayonet fittings. ARIS racks are not included.
- For DAC-9, **unique system rack models were used** rather than a generic rack model used for DAC-8.
- Craig-Bampton reduction performed on all US Lab component models. Modal content to 100 Hz. was retained. Total integrated weight 36325 lb.

Experimental Validation

- Modal Survey Test performed by Boeing Huntsville
- Launch configuration - Common Module with one standoff, one rack, CBM's, Mass Simulators for PMA.
- Frequency range for Model Correlation, 0 to 50 Hz.
- Deflection data from static testing and transfer function correlation studies to further validate on-orbit model.

Vibratory Analysis Finite Element Model Example – US Lab

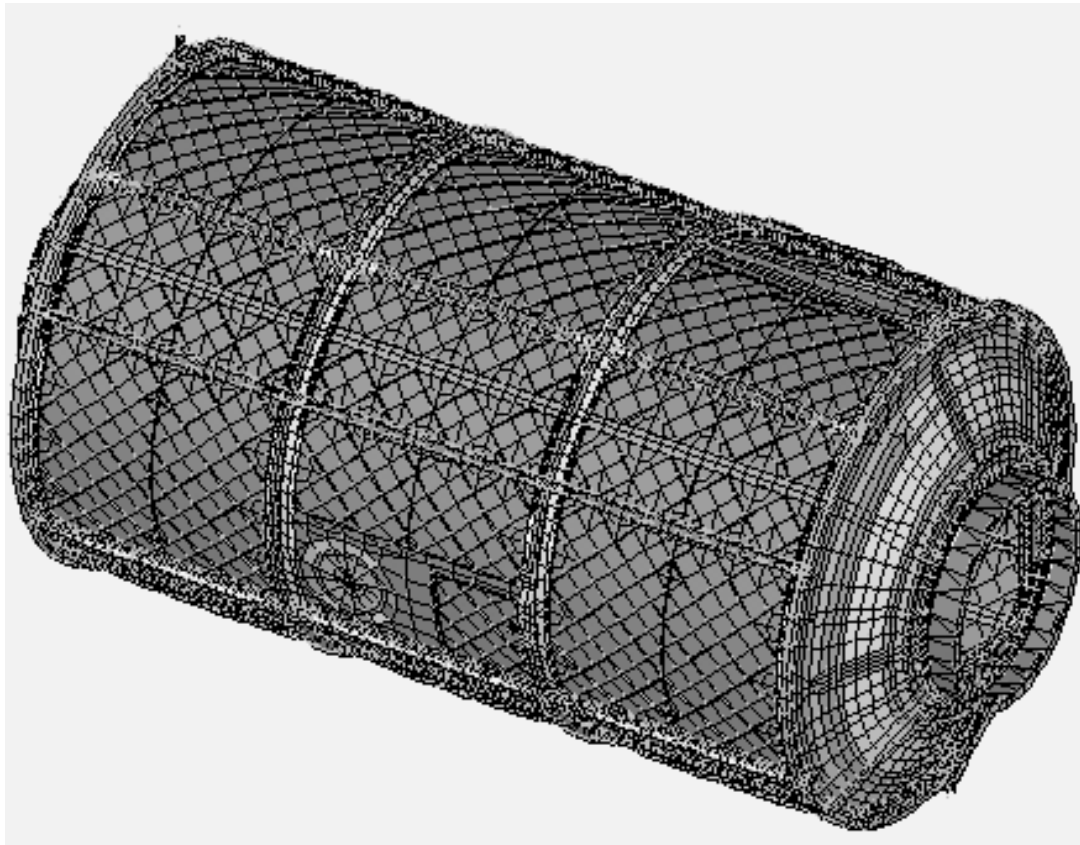

Vibratory Analysis Example Forcing Functions - Exercise Devices Treadmill

- The Service Module (SM) treadmill disturbance definition is based on horizontal test measurements for TVIS certification.
- Measurements include source isolation effects
- Force measurements from 3 cases were used as inputs for transient analysis.
 - speed 1.9, 4.2, and 8.1 mph

Cycle Ergometer

- The US Lab ergometer disturbance definition is based on test measurements for CEVIS certification.
- Measurements include source isolation effects
- Force measurements from 4 cases were used as inputs for the transient analysis.
 - 190 lb. crew member cycling 60, 75, 90, and 105 rpm
- Ergometer mounted on rack seat-tracks in US Lab. Possible relocation to Node 1 in the future.

Vibratory Analysis Example Forcing Functions - Exercise Devices

TVIS Certification Test

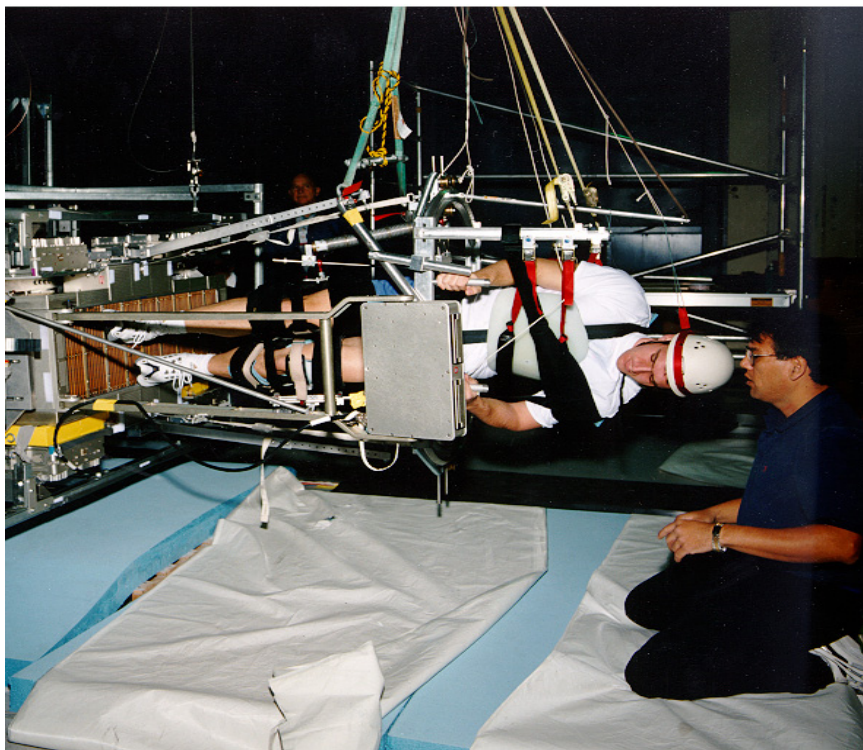

6 DOF Transient Force/Moment For Various Subjects

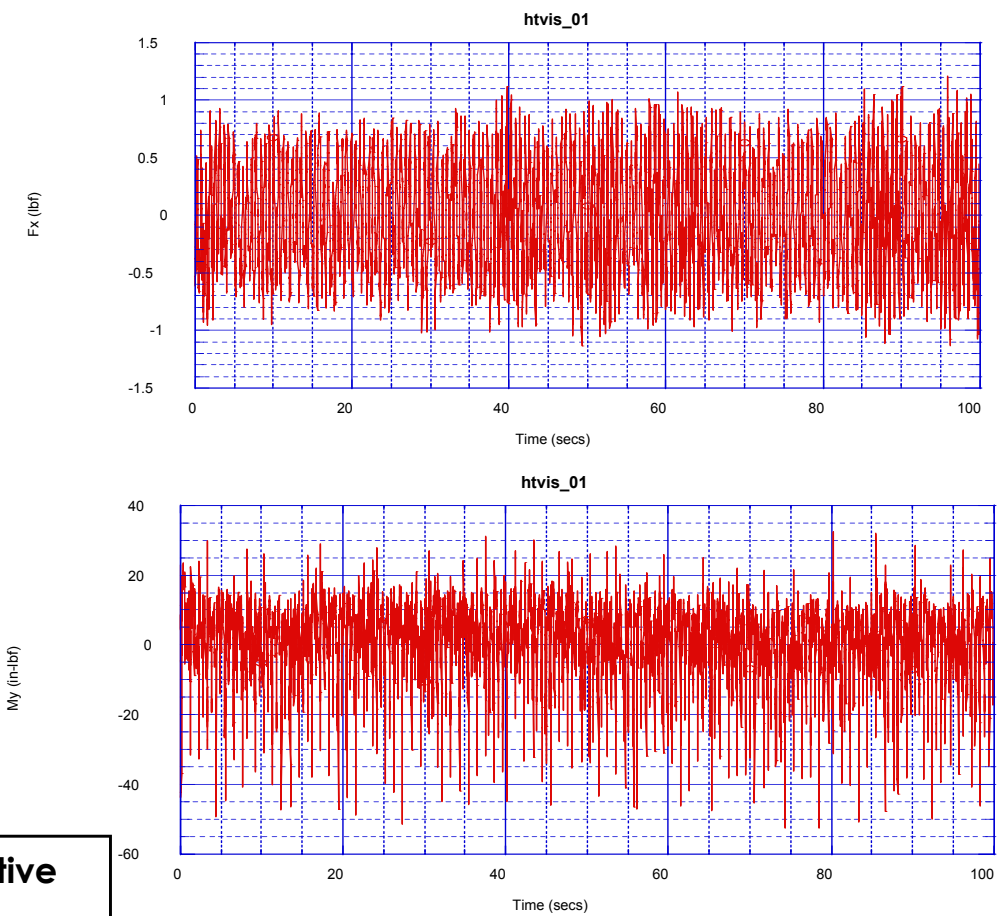

Crew Exercise Equipment: Treadmill, Ergometer, Resistive Exercise Device (Isolated/Non-isolated)

InterVehicular Activity: Translation, Station Keeping, Console Operations, ... Scheduled Maintenance.

Vibratory Results DAC 9 - Composite

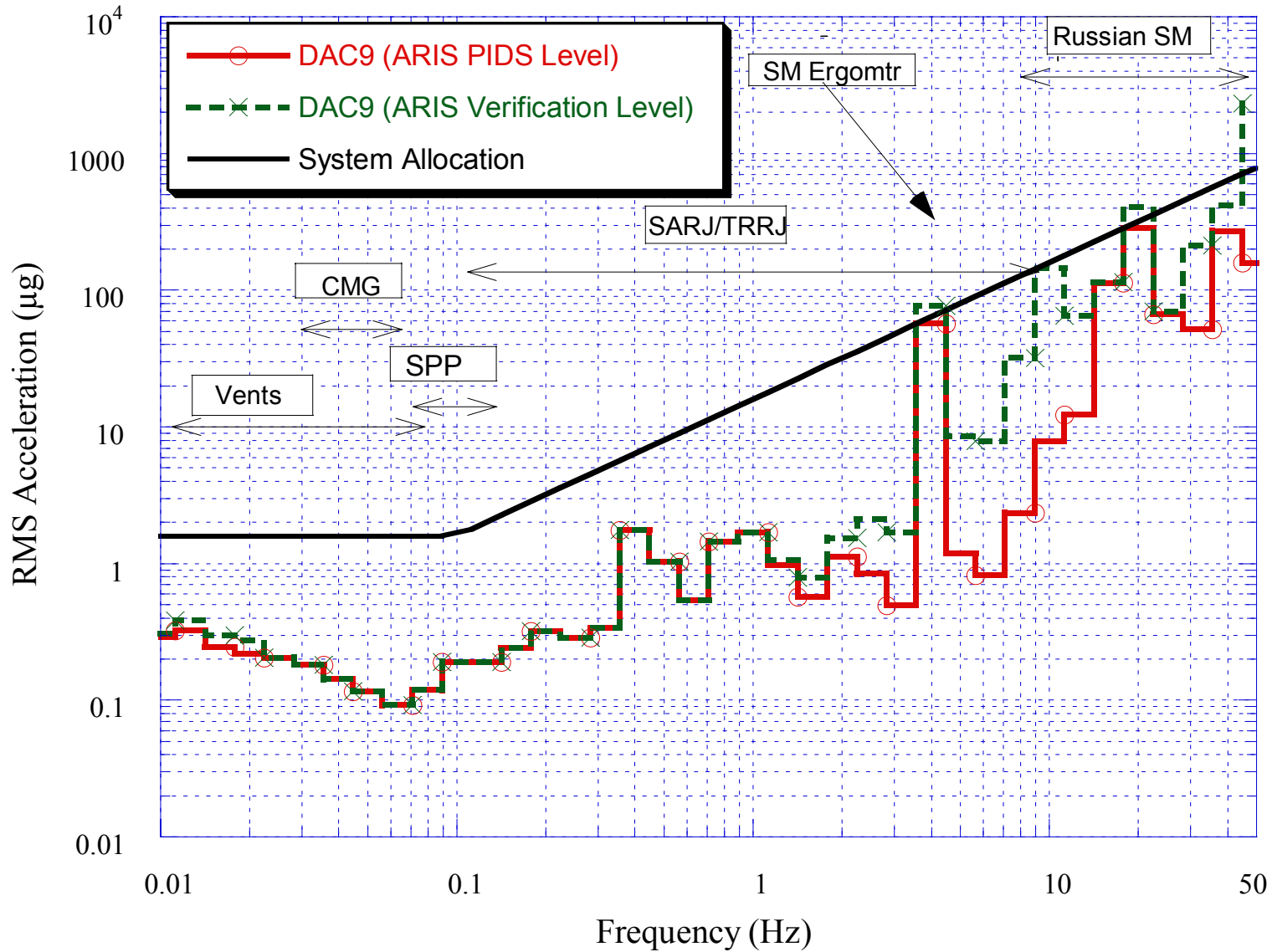

Vibratory Results DAC 9 – USLAB

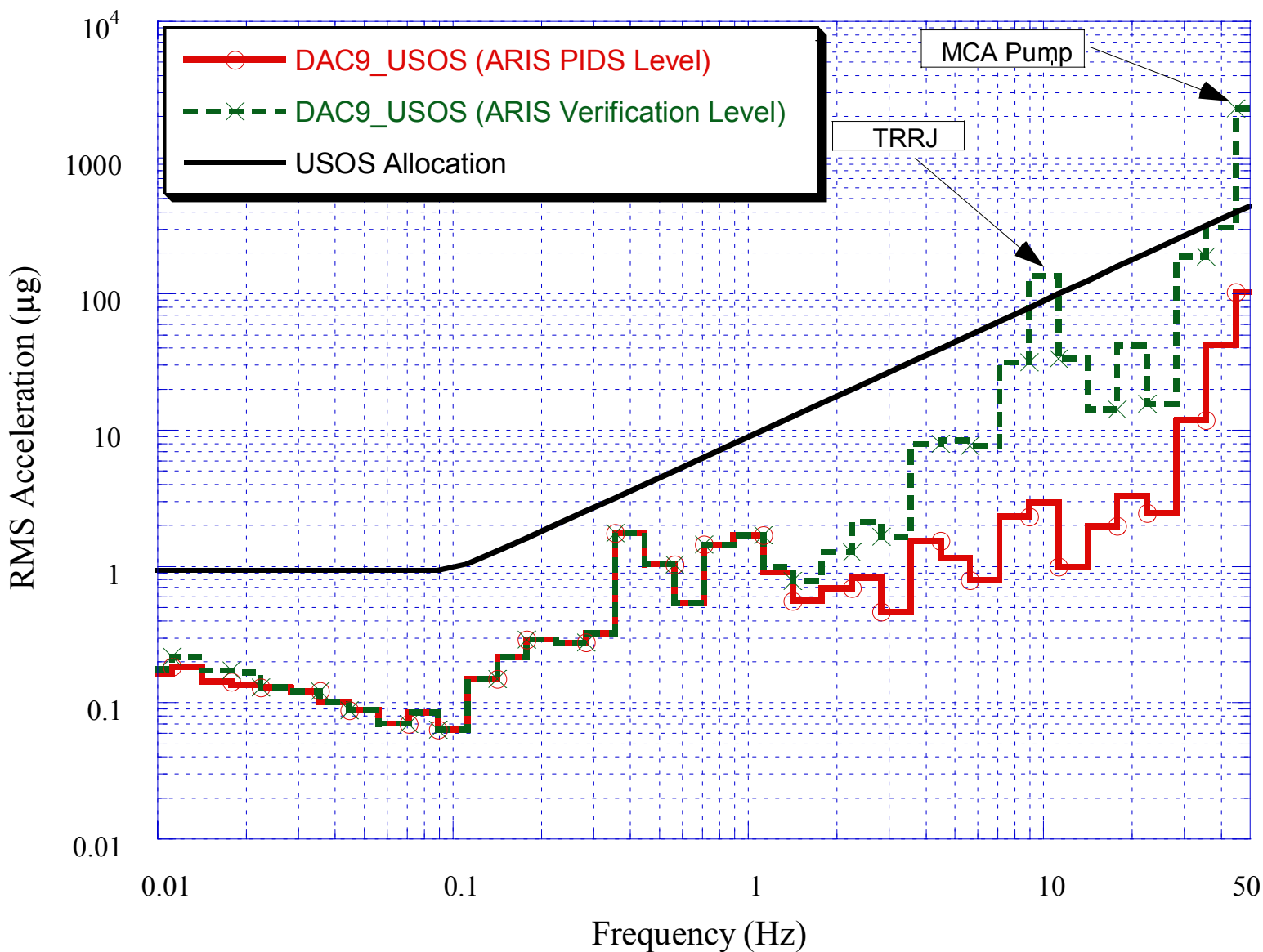

Vibratory Results DAC 9 – COF/CAM

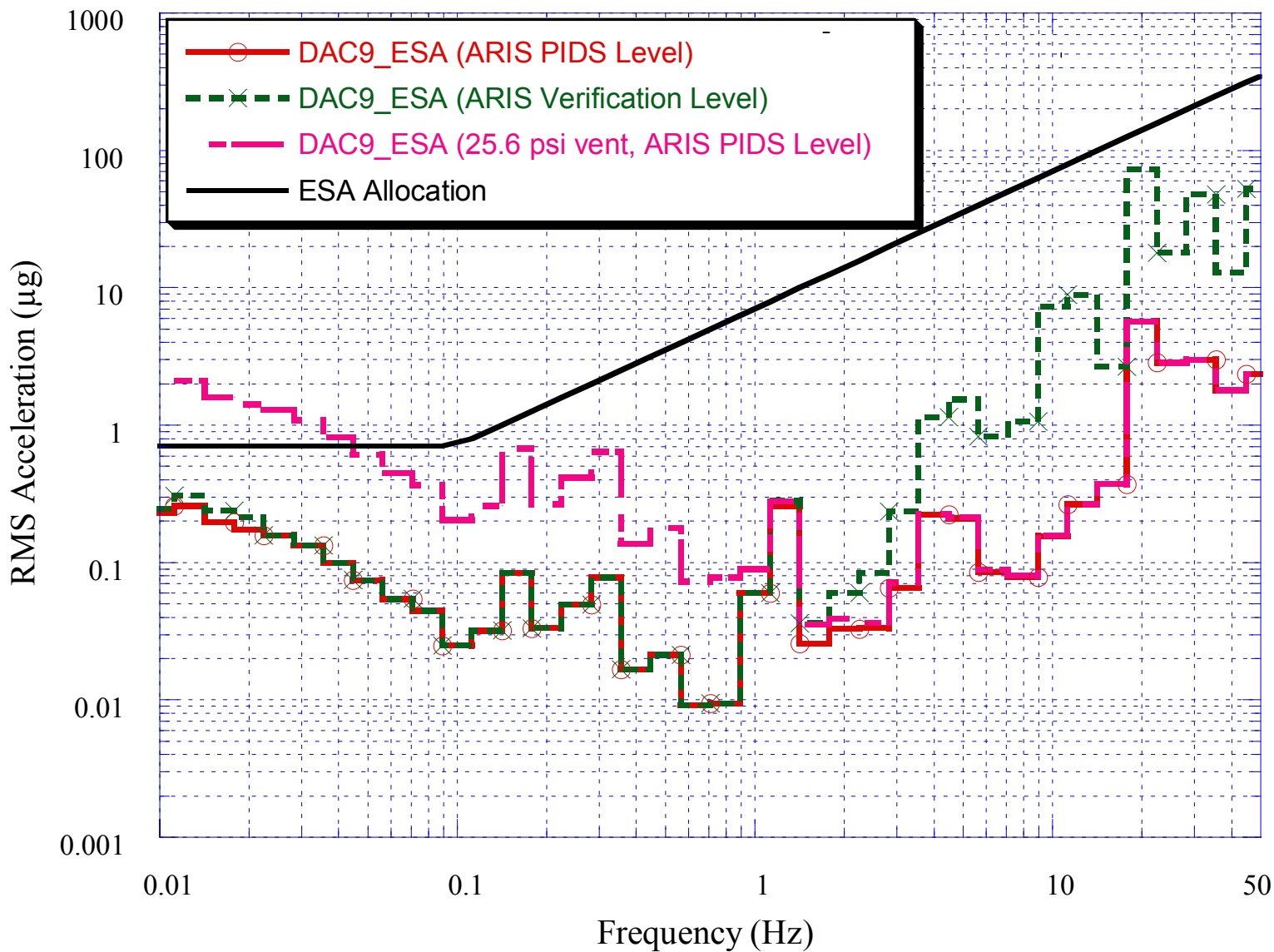

Vibratory Results DAC 9 – JEM

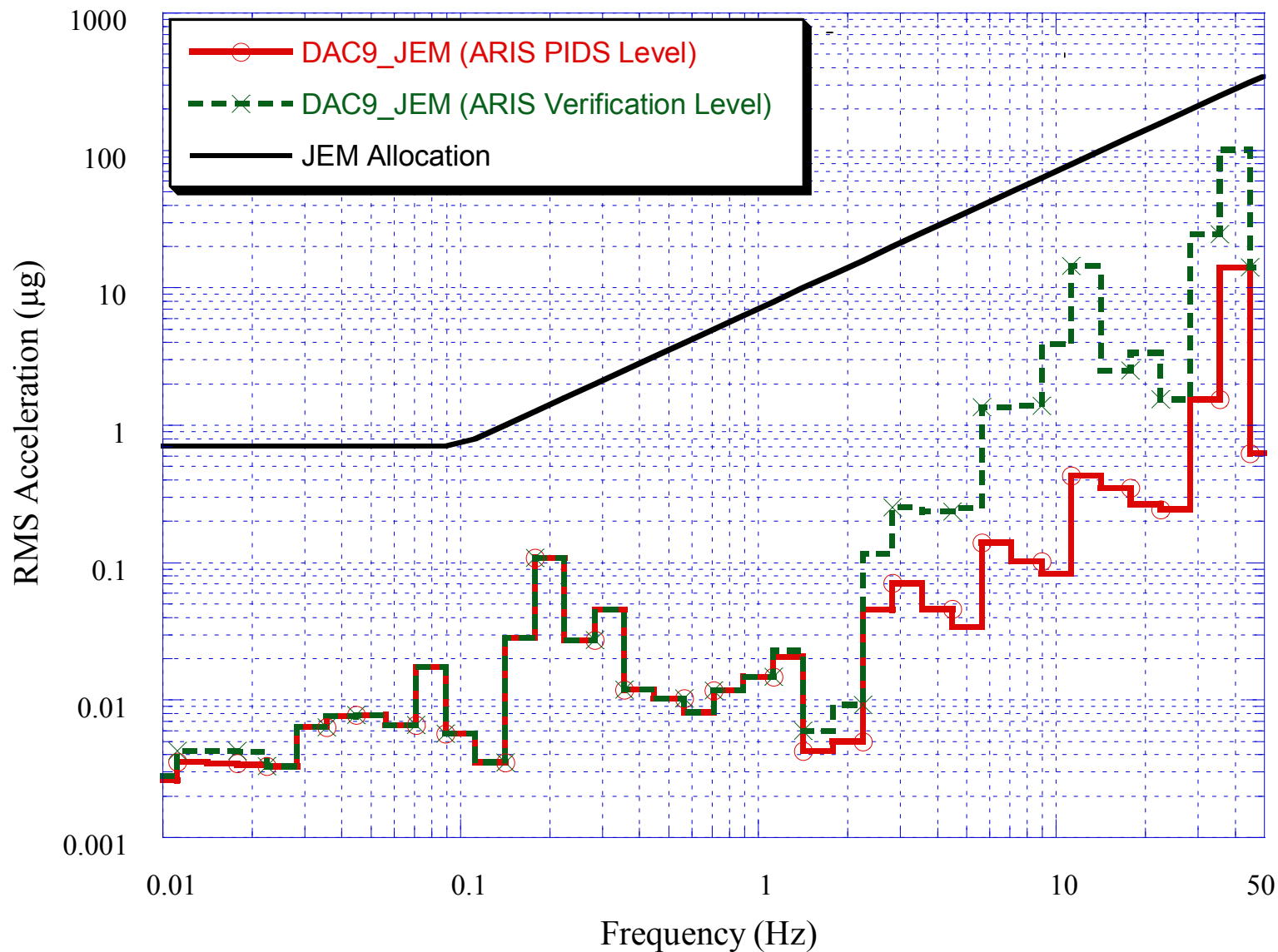

Vibratory Results DAC 9 – Russian Segment (RS)

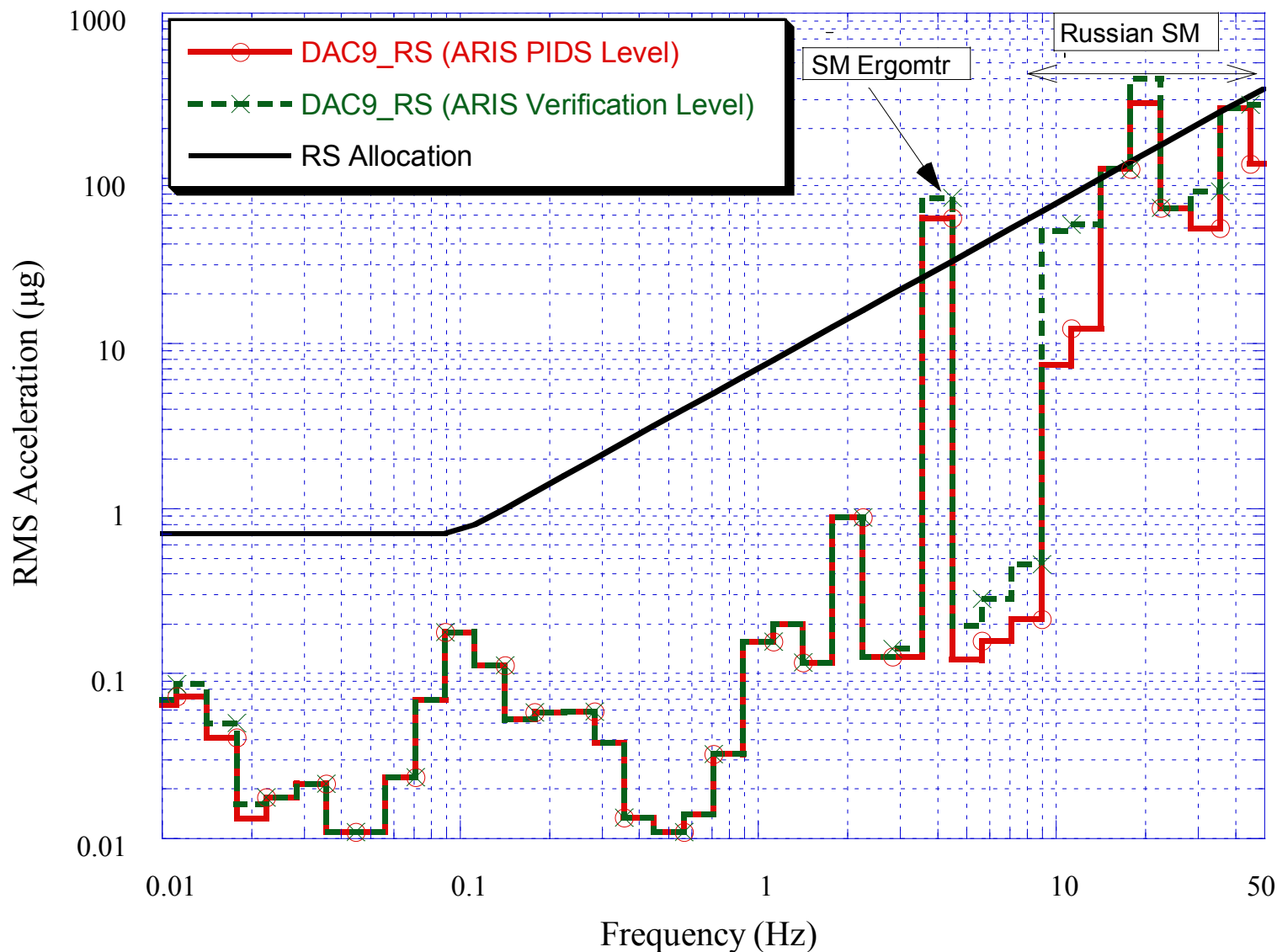

VibroAcoustic Results

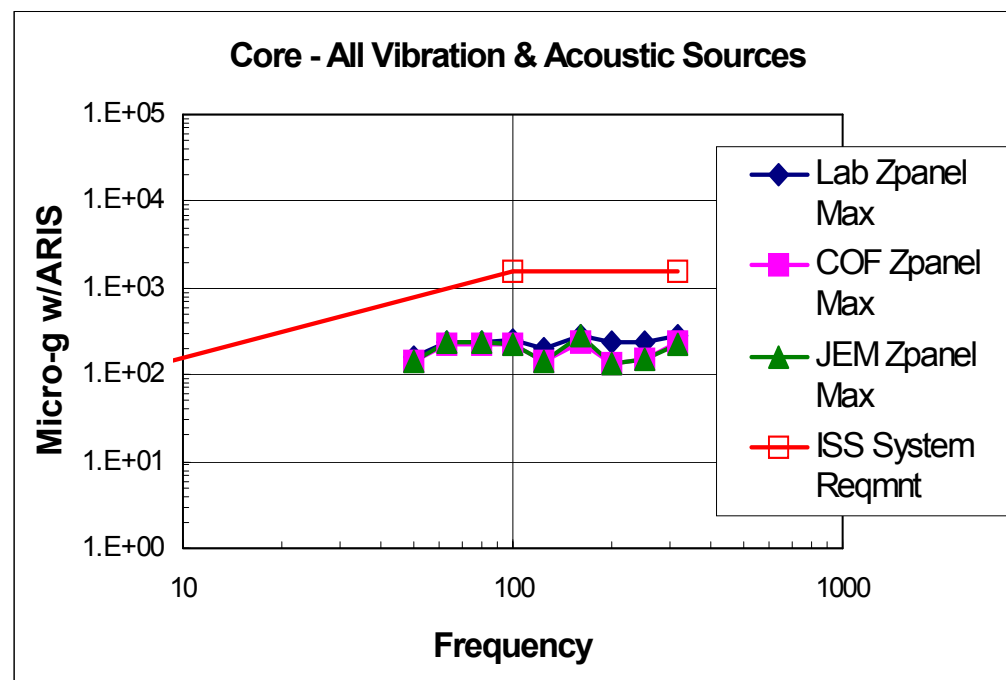
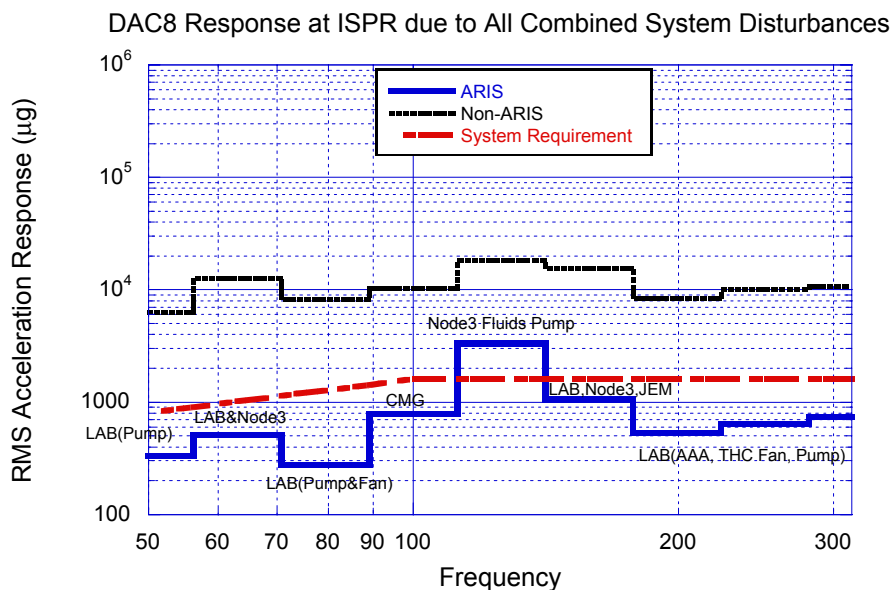

Verification Analysis Cycles

Verification Analysis Cycles (VACs) are in process and are conducted on an increment by increment basis.

- Verify that the hardware launched complies with Assembly Complete microgravity requirements.
- Priority tasks necessary for Certification of Flight Readiness.
- Example: ISS Stage 6A Quasi-steady environment (as measured by MAMS) and SSMRBS was correlated (using actual Solar Flux Data, actual array configuration, and vehicle attitude). Model to environment deviation was only 3-4%.

Microgravity sustaining engineering efforts underway (JSC)

- Use of on-orbit measurements for issue resolution, uncertainty reduction, analytical model correlation.
- Support anomaly resolution and operations.

Non Isolated Rack Analysis

Non-Isolated Rack Assessment (NIRA)

- Uses the DAC models
- Previous Version completed in 1999
- Latest Version completed December 2003*
 - Vibratory range (0.01-50 Hz)
 - VibroAcoustic range (50-300 Hz) in work
 - Updates to disturbers
 - Some changes in methodology
- Reports μg at rack interfaces on a per element (US LAB, JEM, etc.) basis
- Assumptions/Limitations
 - Station in μg mode
 - *Includes payload and crew disturbances*
 - *Does not include active (ARIS) or passive isolation at the crew interface*
- Data used by payload developers
 - More conservative since payload disturbances are included
 - Developer simulates lab to rack isolation technique based on their specific rack configuration

* Contact William Hughes, NASA GRC (william.o.hughes@grc.nasa.gov)

DAC/NIRA Comparison

DAC

- **Vehicle Disturbers/Response**
- **Does not include Payload Disturbers**
- **Includes Active Rack Isolation System (ARIS)**
- **Used by vehicle to show compliance to μg specification requirements**
- **Damping = 0.25%**

NIRA

- **Vehicle Disturbers/Response**
- **Includes Payload Disturbers (Based on Allocations)**
- **Does not include rack isolation (Isolation determined by Payload Developer)**
- **Used by payloads to predict μg levels at rack interfaces**
- **Damping = 1.0%**

NIRA03 - US Lab

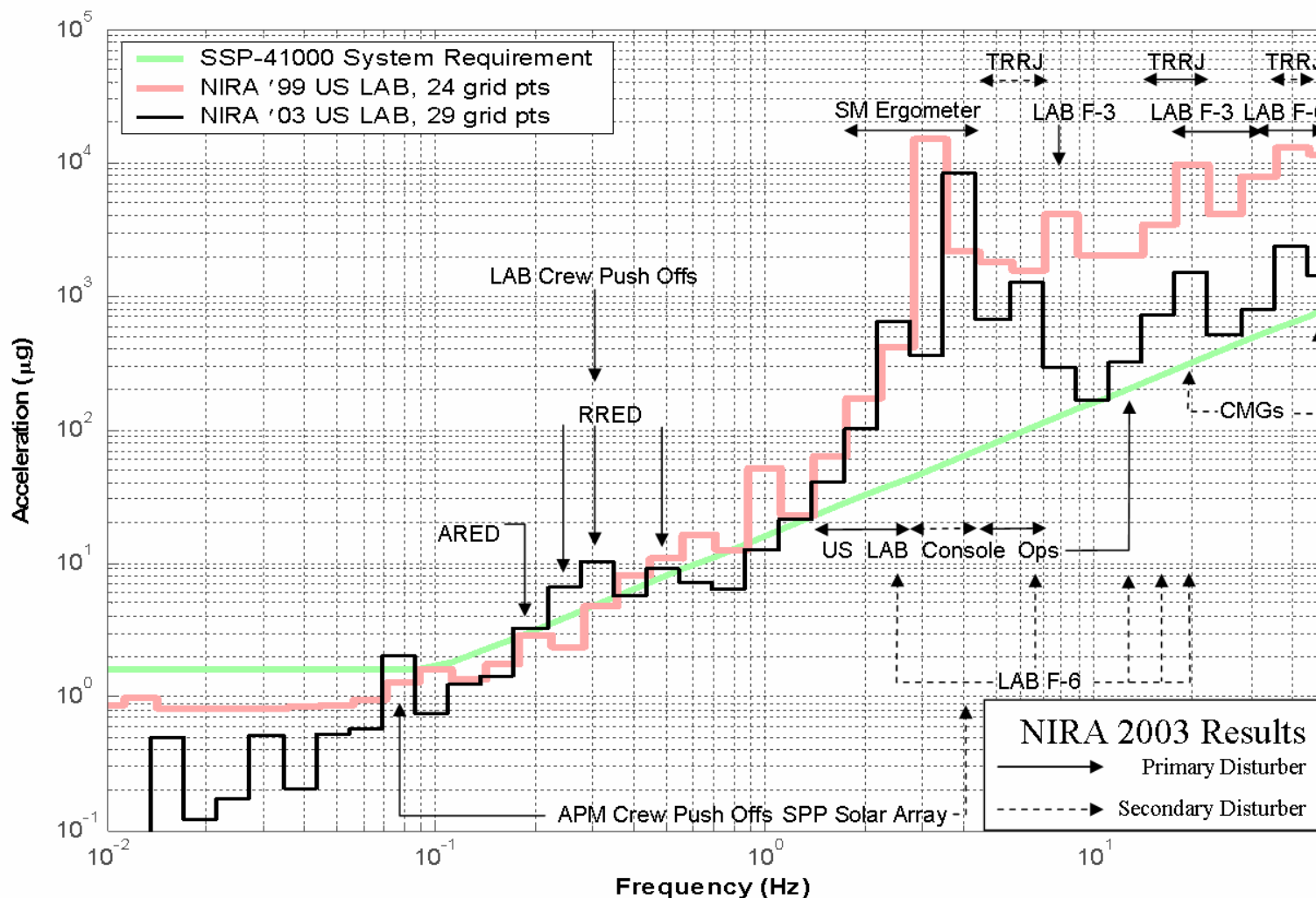

NIRA03 – COF

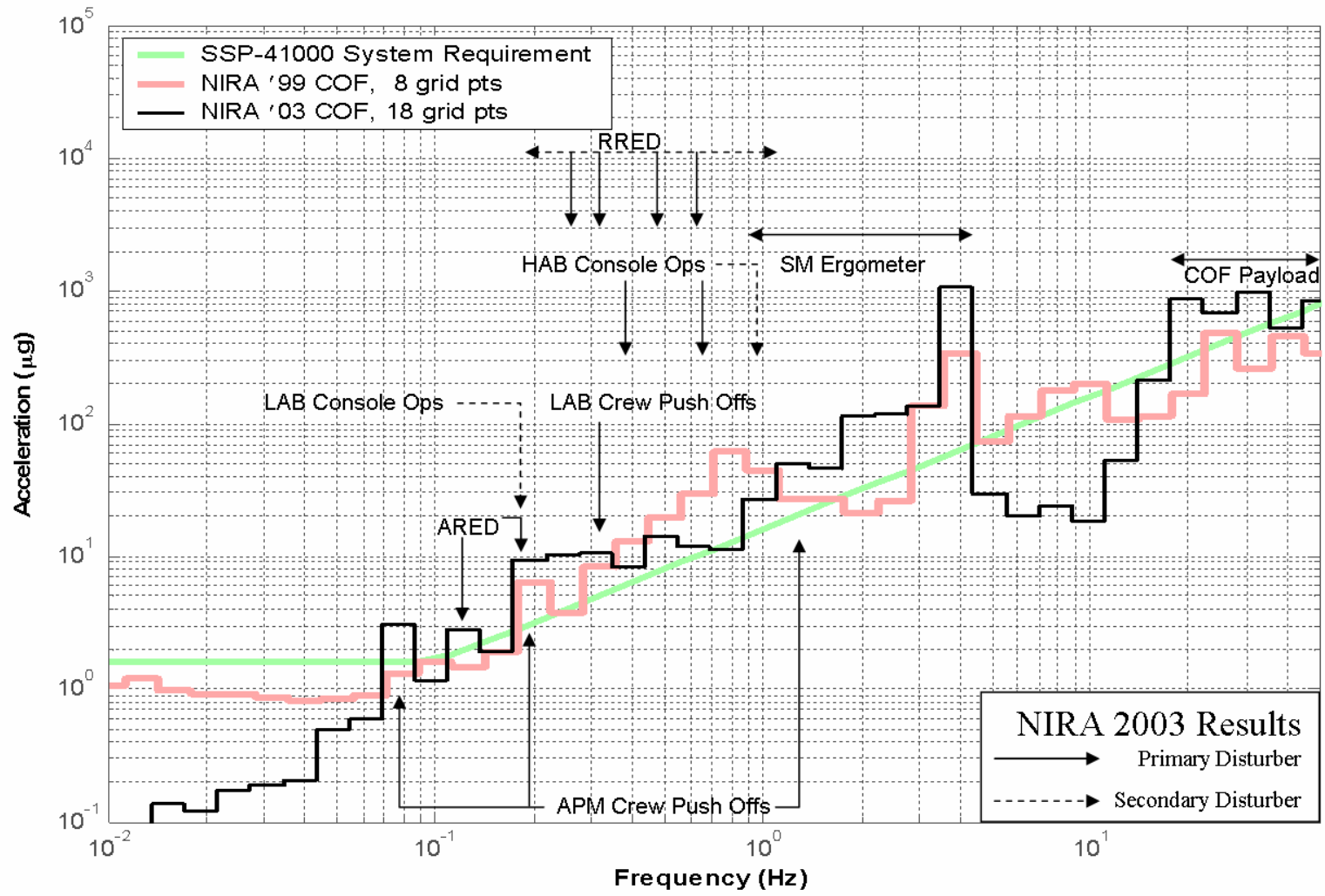

NIRA03 – JEM PM (Pressurized Module)

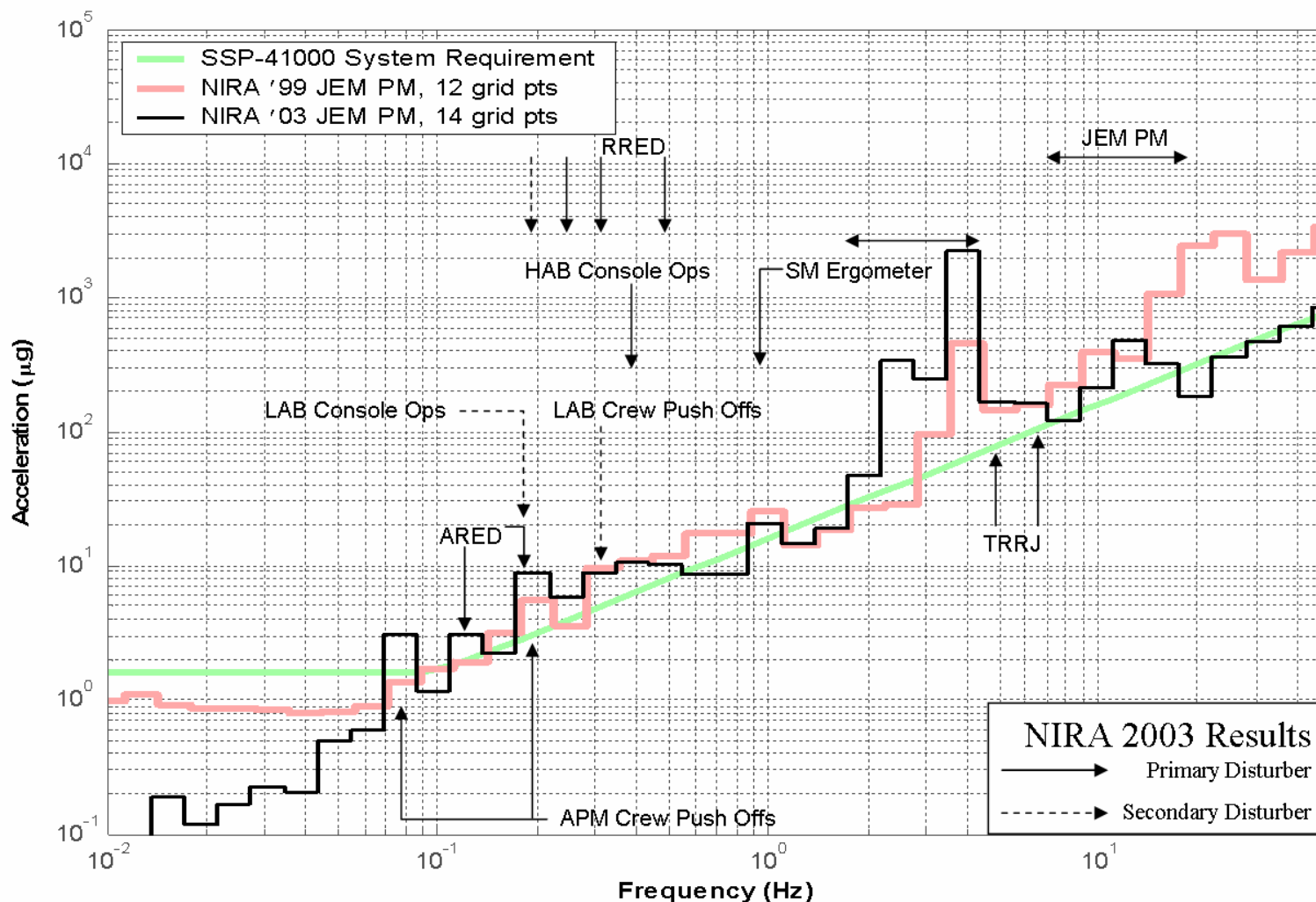

NIRA03 - CAM

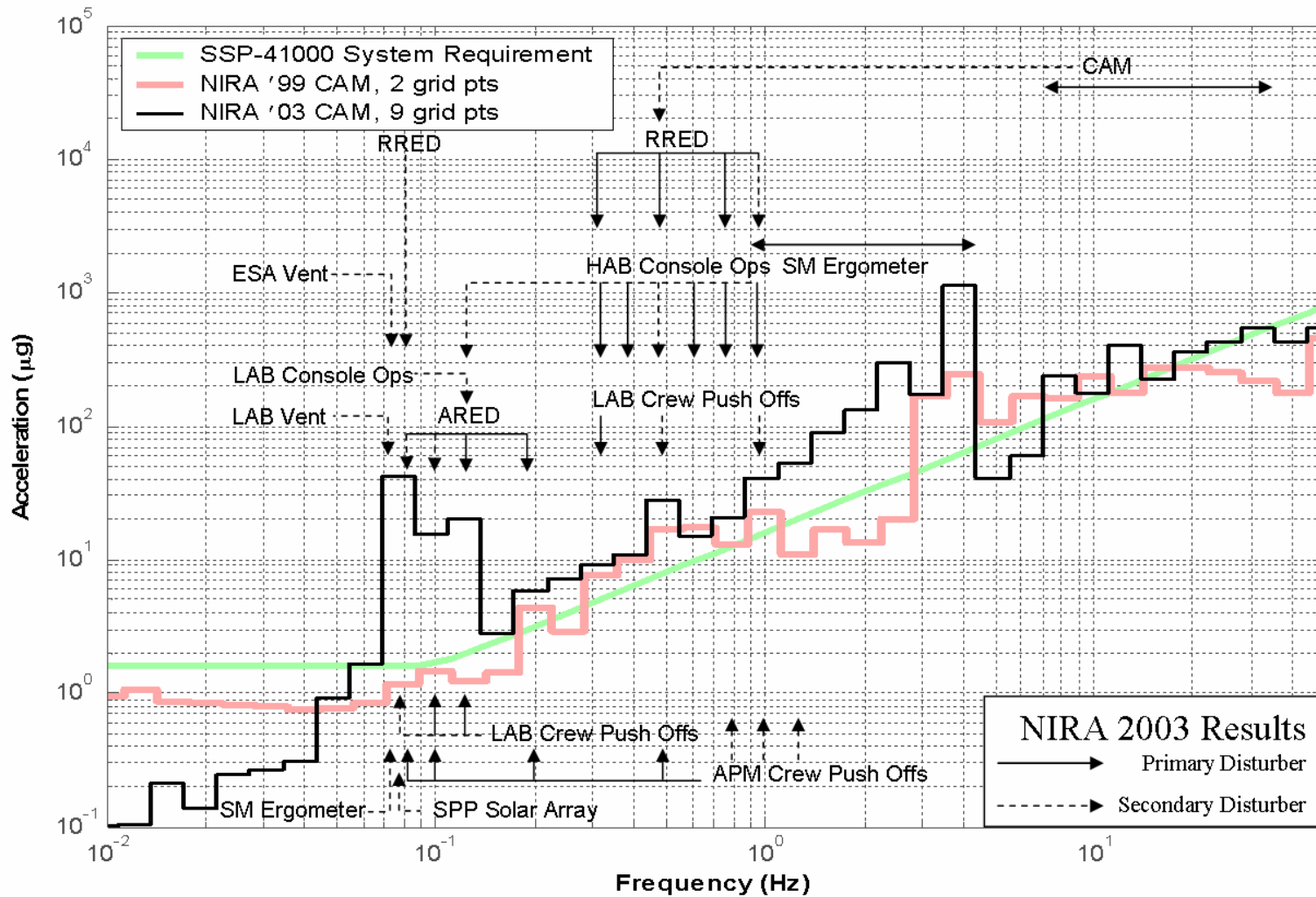

NIRA03

- **“Skylines” also available for**
 - **COF Exposed Payload Facility**
 - **JEM Exposed Facility**
 - **JEM Experiment Logistics Module**
 - **Node 1**
 - **Node 2**
 - **Node 3**
 - **S3 and P3 Trusses**

MAC – Microgravity Analysis Cycle

- **Microgravity Analysis Cycle**
 - **Goals:**
 - ***Provide data that can be utilized to make operational decisions based on the predicted microgravity environment for specific payloads.*** This would allow payload operational decisions to be made based on planned ISS operations.
 - Further leverage the PIMS group's expertise and extensive knowledge base of the ISS microgravity environment and operations ***to better predict the microgravity environment for science payloads***
 - Merge analytical predictions with on-orbit experience/data
 - **Users: payload developers, science community, payload operations planners, PIMS, etc.**
 - **Differs from “Requirements” based analyses, e.g. NIRA & DAC**
 - Requirements based analyses are conservative (for a good reason)
 - methodology uses maximum enveloping of disturbers
 - Multiple operation scenarios applied simultaneously (high and low speed modes of a disturber applied simultaneously for μg envelope)
 - Useful for payload design and requirement analysis; provides overly conservative results for determining operational cases
 - Currently, pre-assembly complete stages are treated as special runs
 - **http://microgravity.grc.nasa.gov/mac_website/**

MAC – Microgravity Analysis Cycle Tool

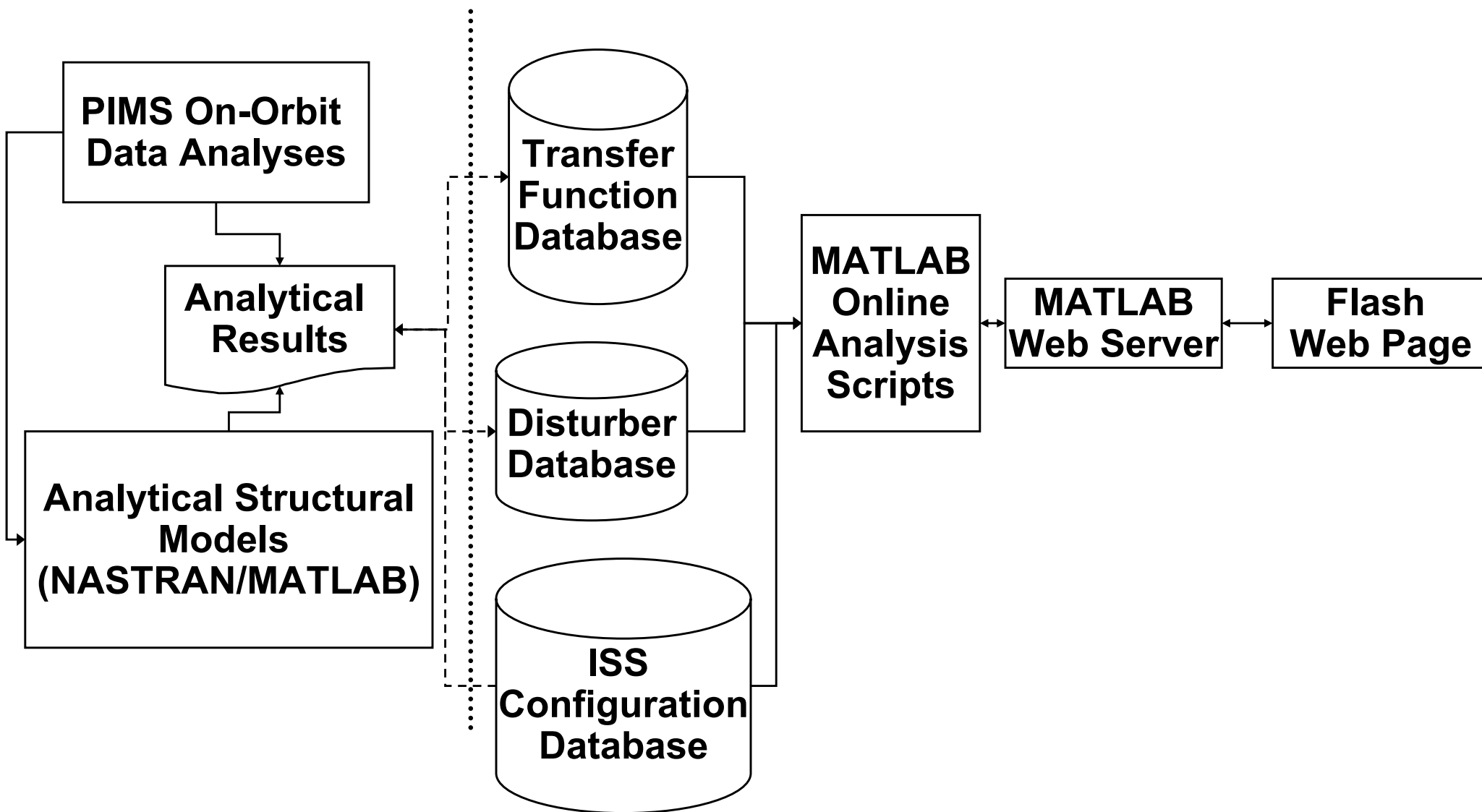

MAC Webpage – Main Page

The screenshot shows the MAC Website Demo interface. At the top, there are navigation tabs: PIMS, MSD, ACCELERATION, and SEARCH. Below these are four main sections: MAIN SWITCHBOARD, VEHICLE DISTURBER, ASSEMBLY STAGE, and RESULTS. A secondary navigation bar includes buttons for Subsystem, Payload, IP Rack, Stowage, Closeout, and Results Available. The main content area displays three rack layouts: Airlock, Columbus, and US Lab (consisting of Node 1 and Node 2). Each rack is divided into overhead, forward, deck, and aft sections. The Columbus rack shows various equipment like ZSR, ESR, FSL, and Bio Lab. The US Lab racks show a grid of equipment including DDCU, HRF, MELF, EXP, TCS, MSSAV, HRF, DDCU, EXP, ARS, AV, CHECS, WORF, AV3, AV2, TCS, MSSAV, EXPR5, FIR, CIR, and TeSS. A 'MAIN SWITCHBOARD' panel on the right indicates that data is currently being processed.

- User can select from different ISS configurations
 - Currently limited to ISS Configuration: UF5
- Racks in “purple” have:
 - Recovery Locations (Results)
 - Configurable Disturbers
- User can select “Vehicle Disturber”

MAC Web Page – Example Rack Page (FIR- Fluids Integrated Rack)

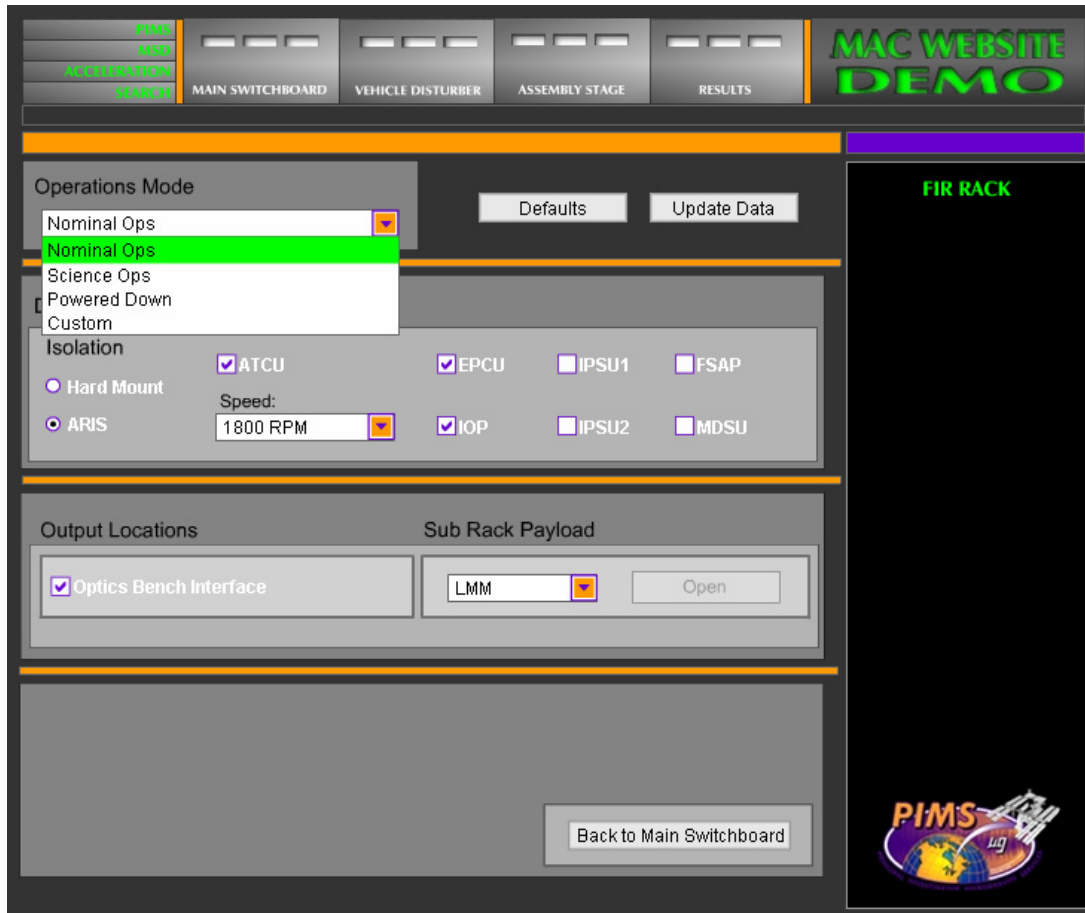

- **User can select among:**
 - **Nominal operations mode**
 - **Predefined modes**
 - “Nominal Ops”
 - “Science Ops”
 - “Powered Down”
 - **Custom mode**
 - User selects desired disturbers

- **User selects requested output (recovery) location by checking check box**

MAC Web Page – Vehicle Disturbers

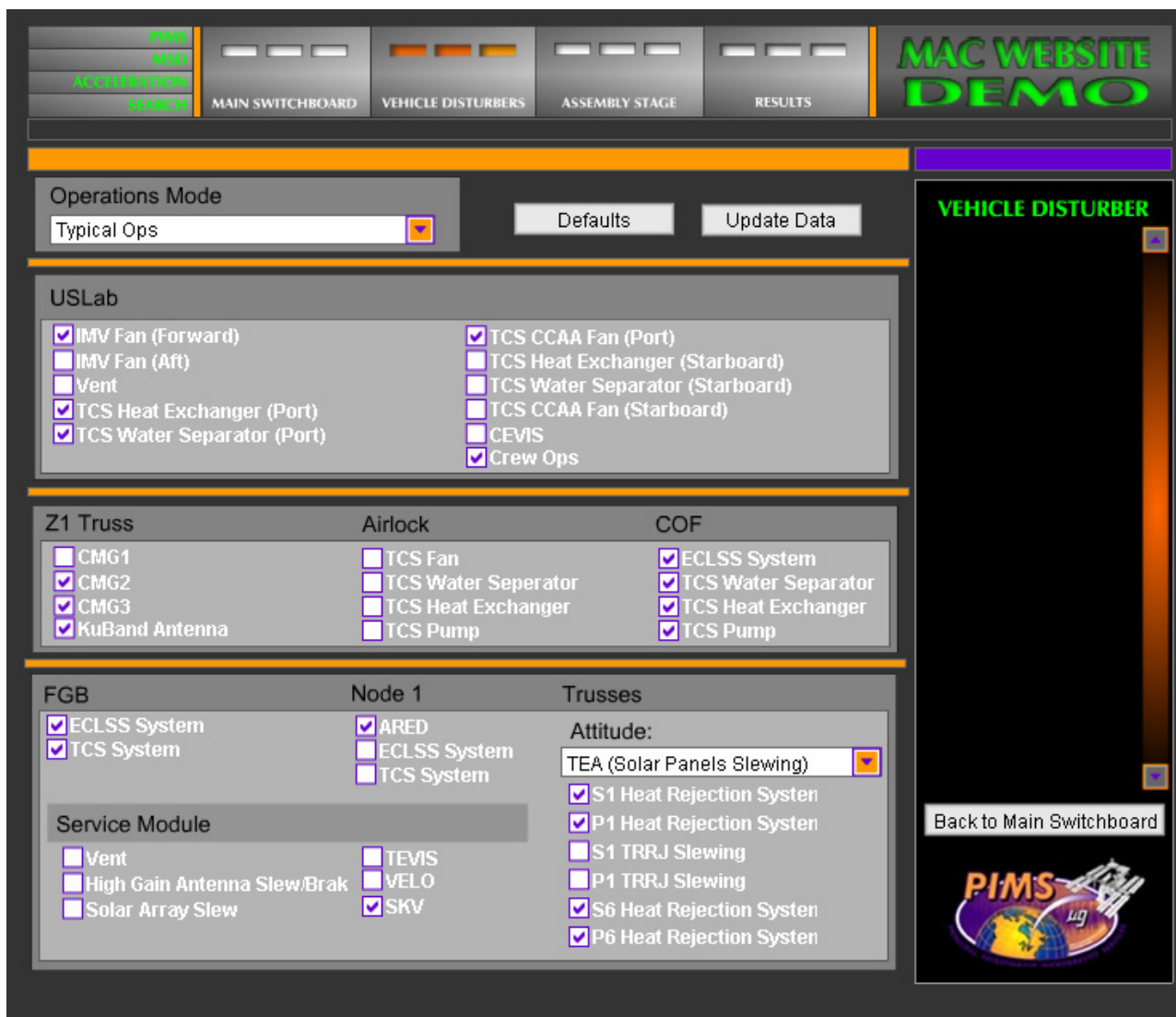

The screenshot shows the MAC Website Demo interface. At the top, there are navigation tabs: PIMS, MSD, ACCELERATION, and SEARCH. Below these are four main sections: MAIN SWITCHBOARD, VEHICLE DISTURBERS (selected), ASSEMBLY STAGE, and RESULTS. The VEHICLE DISTURBERS section is active, showing a dropdown menu for Operations Mode set to 'Typical Ops', and buttons for Defaults and Update Data. The main content area is divided into several sections with checkboxes for various disturbers:

- USLab:**
 - IMV Fan (Forward)
 - IMV Fan (Aft)
 - Vent
 - TCS Heat Exchanger (Port)
 - TCS Water Separator (Port)
 - TCS CCAA Fan (Port)
 - TCS Heat Exchanger (Starboard)
 - TCS Water Separator (Starboard)
 - TCS CCAA Fan (Starboard)
 - CEVIS
 - Crew Ops
- Z1 Truss:**
 - CMG1
 - CMG2
 - CMG3
 - KuBand Antenna
- Airlock:**
 - TCS Fan
 - TCS Water Separator
 - TCS Heat Exchanger
 - TCS Pump
- COF:**
 - ECLSS System
 - TCS Water Separator
 - TCS Heat Exchanger
 - TCS Pump
- FGB:**
 - ECLSS System
 - TCS System
- Node 1:**
 - ARED
 - ECLSS System
 - TCS System
- Trusses:**
 - Attitude: TEA (Solar Panels Slewing)
 - S1 Heat Rejection System
 - P1 Heat Rejection System
 - S1 TRRJ Slewing
 - P1 TRRJ Slewing
 - S6 Heat Rejection System
 - P6 Heat Rejection System
- Service Module:**
 - Vent
 - High Gain Antenna Slew/Brak
 - Solar Array Slew
 - TEVIS
 - VELO
 - SKV

At the bottom of the VEHICLE DISTURBER panel, there is a 'Back to Main Switchboard' button and a PIMS logo.

- User can select amongst:
 - Typical operations mode
 - Active disturbers chosen based on PIMS experience for “typical” operations
 - Analytical Predictions (NIRA)
 - NIRA levels are applied at rack interfaces in place of station disturbers
 - Custom mode
 - User selects desired disturbers

Main Switchboard

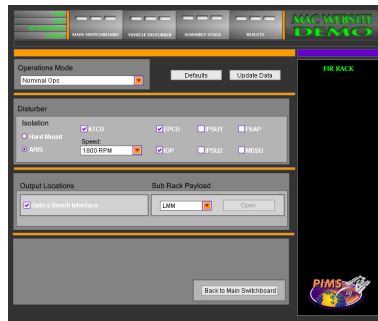
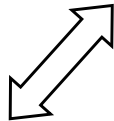

FIR Rack Page

- Choose “Nominal Ops”
- ATCU, EPCU, IOP, ARIS become active
- Choose “Optics Bench” for results

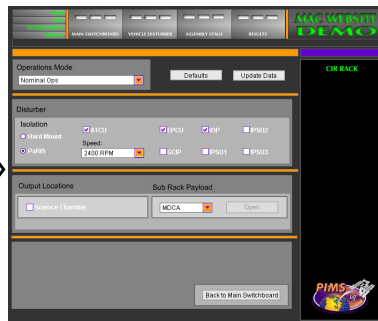

CIR Rack Page

- Choose “Nominal Ops”
- ATCU, EPCU, IOP, PaRIS become active

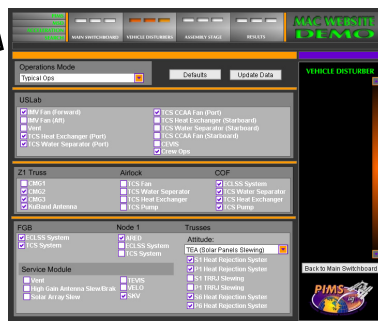
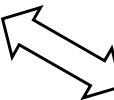

Vehicle Disturbers Page

- Choose “Typical Ops”
- US Lab IMV Fan, TCS Components, CMG 2 & 3, etc. become active

Results Page

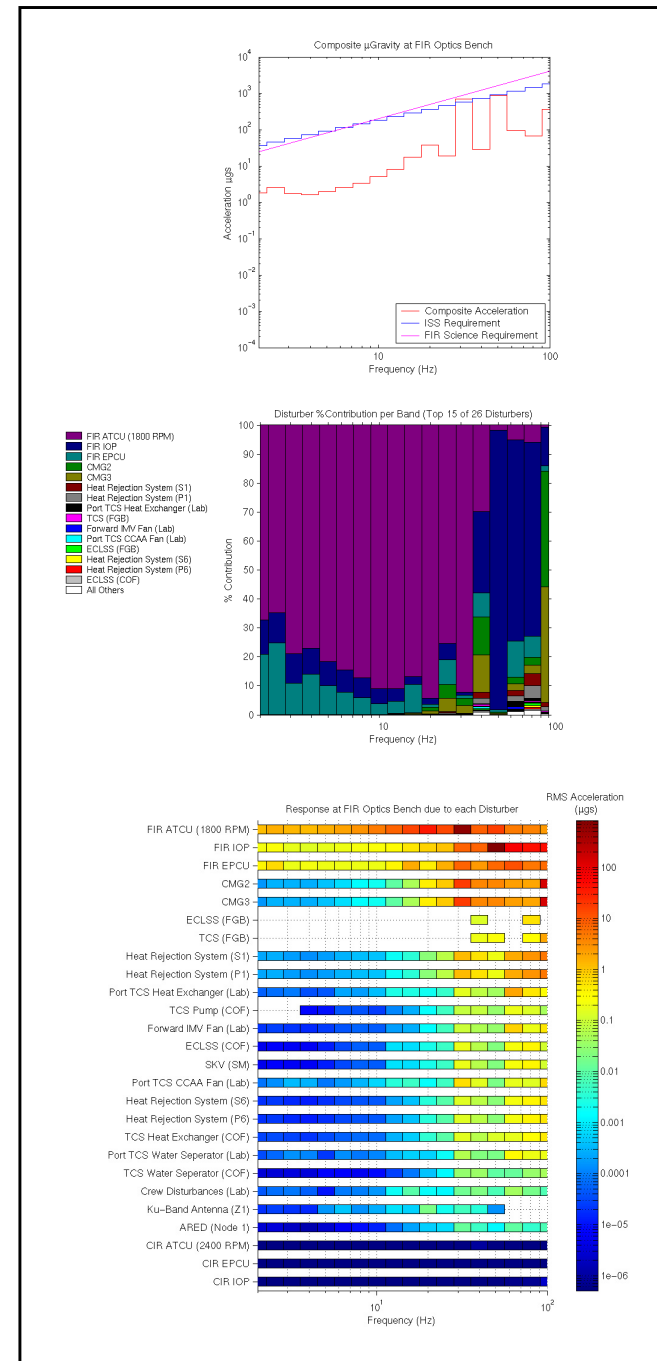
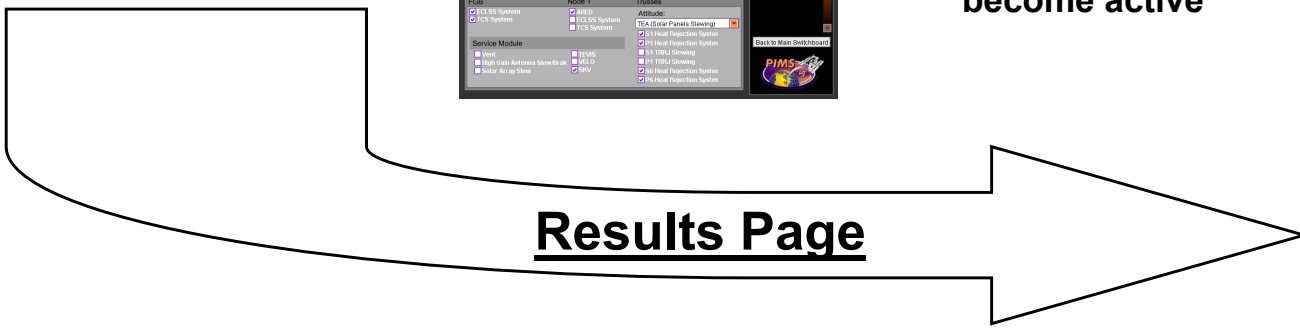

Results – Figure 1

What is the μg environment at the selected output location?

Output Location

Composite μg Gravity at FIR Optics Bench

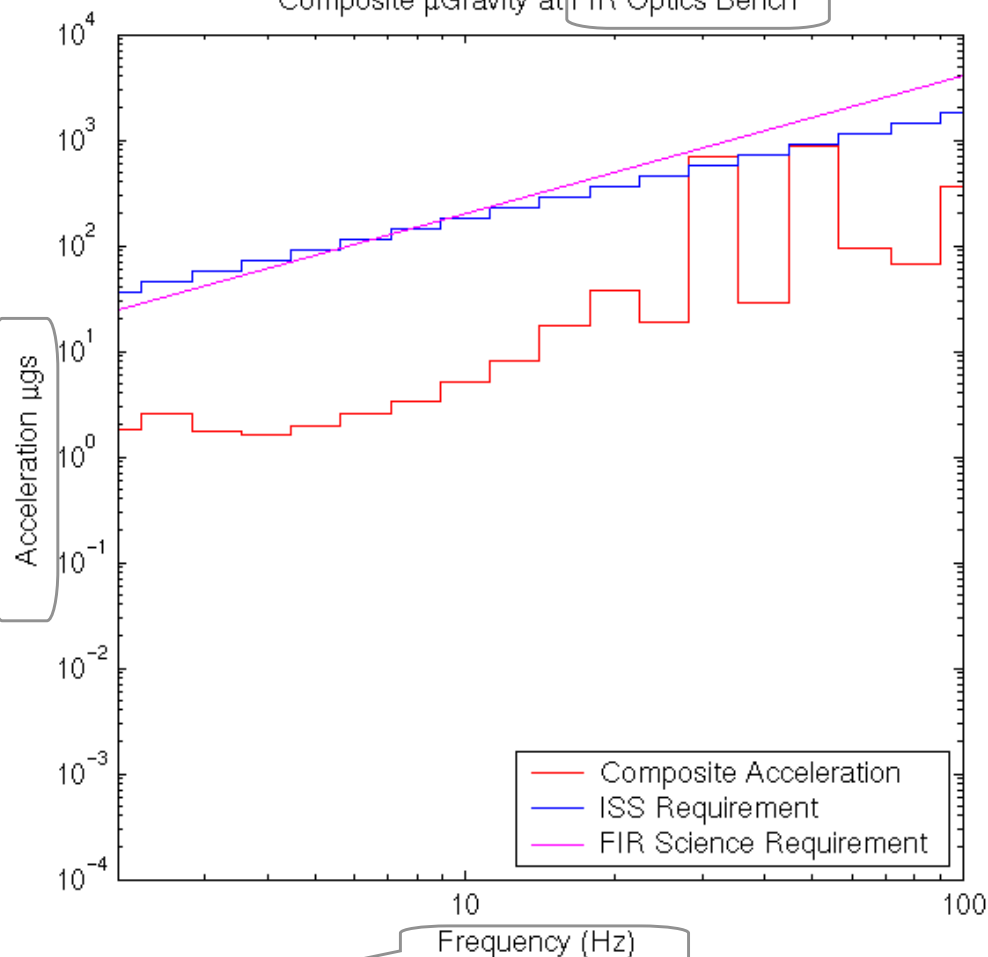

μg Level

- Composite Level
- Requirements (as applicable)

Frequency

- In One Third Octave Bands

Results – Figure 2

What disturbers are significantly contributing to the μg environment at the selected output location?

Top 15 Contributors

Most
(across the spectrum)

Least

All Other Contributors
Combined

- FIR ATCU (1800 RPM)
- FIR IOP
- FIR EPCU
- CMG2
- CMG3
- Heat Rejection System (S1)
- Heat Rejection System (P1)
- Port TCS Heat Exchanger (Lab)
- TCS (FGB)
- Forward IMV Fan (Lab)
- Port TCS CCAA Fan (Lab)
- ECLSS (FGB)
- Heat Rejection System (S6)
- Heat Rejection System (P6)
- ECLSS (COF)
- All Others

%Contribution
•Contribution of
disturber in the
OTOB

•In One Third Octave Bands (OTOB)

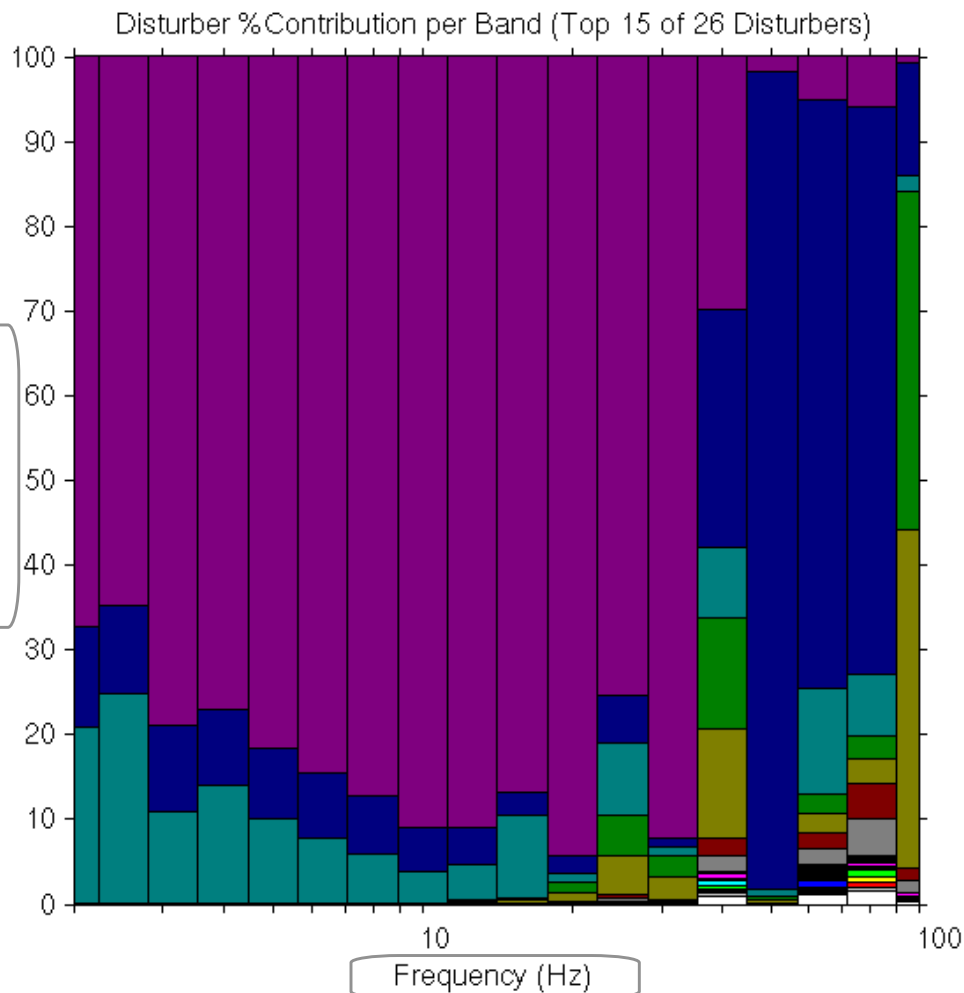

Frequency

Results - Figure 3

What are the RMS acceleration levels from each disturber at the selected output location?

Each Disturber

•Horizontal Bar

Most Contribution
(across the spectrum)

Least Contribution

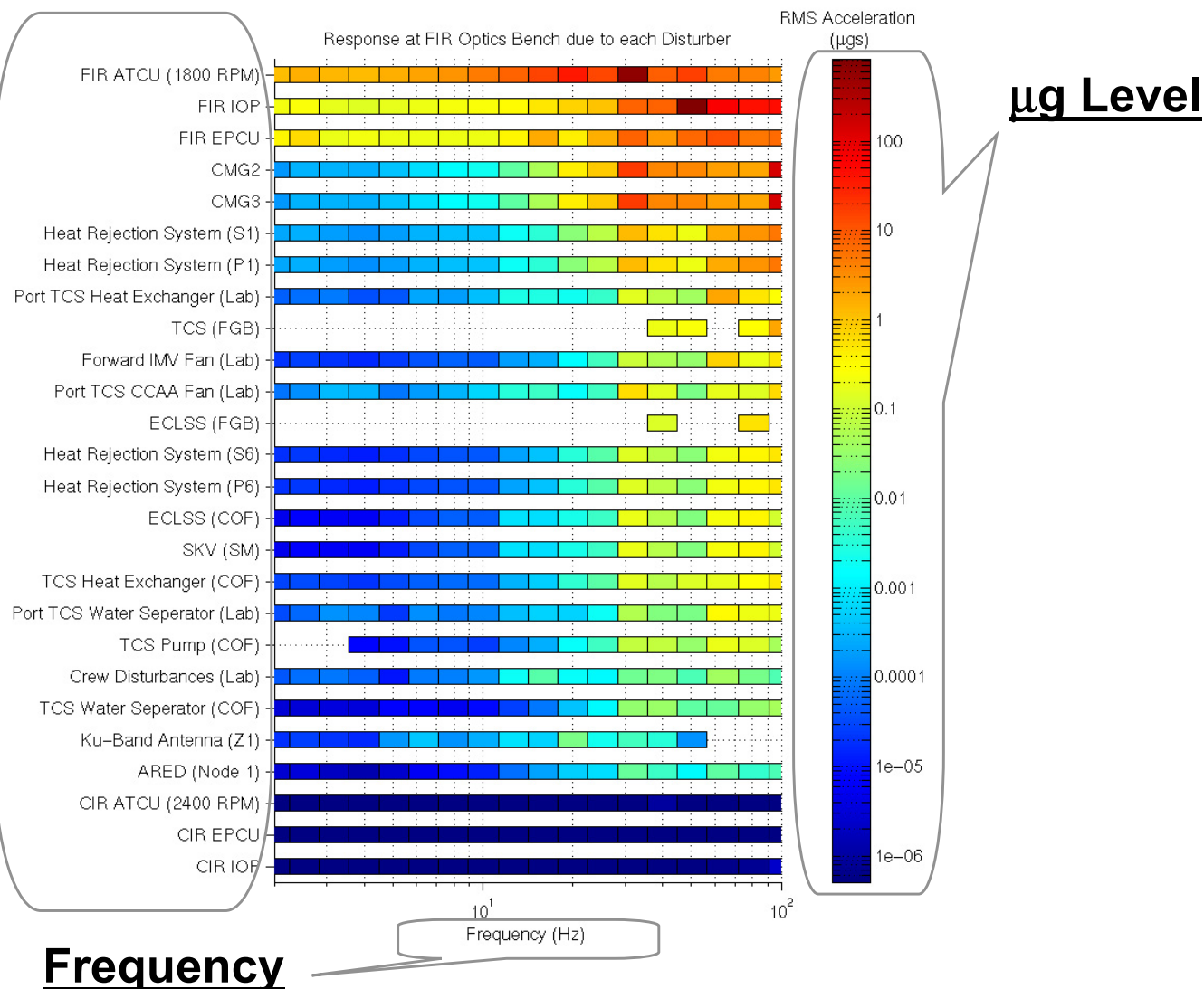

•In One Third Octave Bands (OTOB)

MAC Development Status

- **Frequency Range**
 - Example above shows 2-100 Hz
 - Will increase to 0.01 to 100 Hz for periodic disturbers
 - Will increase to 0.01 to 50 Hz for transients
- **ISS Assembly Configurations**
 - Currently completing UF2 and UF5
 - Results on preceding pages are not actual predicted values
 - Will expand to all other assembly stages
- **Web Page**
 - **Adding Help Pages**
 - Tutorial
 - Plain English description of payload and vehicle disturbers
 - Links to PIMS handbook pages
 - **Report Page**
 - Summary of user inputs
 - Summary of model configuration (configuration management)
 - **Methodology Page**
 - Details describing methodology in generating analytical results

Summary

- **Quasi-steady Environment – SSMRBS**
- **Vibratory from 0.01 to 50 Hz – FEA**
- **Vibratory from 50 Hz to 360 Hz - SEA**
- **Design Analysis Cycle**
 - **DAC predictions to show vehicle compliance to requirements**
- **Non-Isolated Rack Assessment**
 - **NIRA used by payload developers in conjunction with Isolation (ARIS, PaRIS, None) to assess environment**
- **Design Analysis Cycle**
 - **<http://microgravity.grc.nasa.gov/mac> website**
 - **In development**
 - **Provide data that can be utilized to make operational decisions based on the predicted microgravity environment for specific payloads**